

# AVerMedia<sup>®</sup> AVerDiGi EB5416DVD Pro

---

## User Manual



## FCC NOTICE (Class A)



This device complies with Part 15 of the FCC Rules. Operation is subject to the following two conditions: (1) this device may not cause harmful interference, and (2) this device must accept any interference received, including interference that may cause undesired operation.

## Federal Communications Commission Statement

NOTE- This equipment has been tested and found to comply with the limits for a Class A digital device, pursuant to Part 15 of the FCC Rules. These limits are designed to provide reasonable protection against harmful interference in a residential installation. This equipment generates uses and can radiate radio frequency energy and, if not installed and used in accordance with the instructions, may cause harmful interference to radio communications. However, there is no guarantee that interference will not occur in a particular installation. If this equipment does cause harmful interference to radio or television reception, which can be determined by tuning the equipment off and on, the user is encouraged to try to correct the interference by one or more of the following measures:

- Reorient or relocate the receiving antenna.
- Increase the separation between the equipment and receiver.
- Connect the equipment into an outlet on a circuit different from that to which the receiver is connected.
- Consult the dealer or an experienced radio/television technician for help.

## Class A ITE

Class A ITE is a category of all other ITE which satisfies the class A ITE limits but not the class B ITE limits. Such equipment should not be restricted in its sale but the following warning shall be included in the instructions for use:

**Warning** -This is a class A product. In a domestic environment this product may cause radio interference in which case the user may be required to take adequate measures.

## European Community Compliance Statement (Class A)



This product is herewith confirmed to comply with the requirements set out in the Council Directives on the Approximation of the laws of the Member States relating to Electromagnetic Compatibility Directive 2004/108/EEC.

**Warning** - This is a Class A product. In a domestic environment this product may cause radio interference in which case the user may be required to take adequate measures to correct this interference.

## DISCLAIMER

No warranty or representation, either expressed or implied, is made with respect to the contents of this documentation, its quality, performance, merchantability, or fitness for a particular purpose. Information presented in this documentation has been carefully checked for reliability; however, no responsibility is assumed for inaccuracies. The information contained in this documentation is subject to change without notice.

In no event will AVerMedia be liable for direct, indirect, special, incidental, or consequential damages arising out of the use or inability to use this product or documentation, even if advised of the possibility of such damages.

## TRADEMARKS

AVerMedia is registered trademarks of AVerMedia TECHNOLOGIES, Inc. IBM PC is a registered trademark of International Business Machines Corporation. Macintosh is a registered trademark of Apple Computer, Inc. Microsoft is a registered trademark and Windows is a trademark of Microsoft Corporation. All other products or corporate names mentioned in this documentation are for identification and explanation purposes only, and may be trademarks or registered trademarks of their respective owners.

## COPYRIGHT

© 2008 by AVerMedia INFORMATION, Inc. All rights reserved. No part of this publication may be reproduced, transmitted, transcribed, stored in a retrieval system, or translated into any language in any form by any means without the written permission of AVerMedia INFORMATION, Inc.

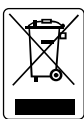

The mark of Crossed-out wheeled bin indicates that this product must not be disposed of with your other household waste. Instead, you need to dispose of the waste equipment by handing it over to a designated collection point for the recycling of waste electrical and electronic equipment. For more information about where to drop off your waste equipment for recycling, please contact your household waste disposal service or the shop where you purchased the product.

## Battery Safety Information

- Store the batteries in a cool dry place.
- Do not dispose of used batteries in domestic waste. Dispose of batteries at special collection points or return to point of sale if applies.
- Remove the batteries during long periods of non-use. Always remove exhausted batteries from the remote control. Battery leakage and corrosion can damage this remote control, dispose of batteries safely.
- Do not mix old and new batteries.
- Do not mix different types of batteries: alkaline, standard (carbon-zinc) or rechargeable (nickel-cadmium).
- Do not dispose of batteries in a fire. The batteries may explode or leak.
- Never short circuit the battery terminals.

**WARNING**

TO REDUCE RISK OF FIRE OR ELECTRIC SHOCK, DO NOT EXPOSE THIS APPLIANCE TO RAIN OR MOISTURE

**CAUTION**

IF THERE IS ANY DAMAGE, SHORTAGE OR INAPPROPRIATE ITEM IN THE PACKAGE, PLEASE CONTACT WITH YOUR LOCAL DEALER. WARRANTY VOID FOR ANY UNAUTHORIZED PRODUCT MODIFICATION

**NOTICE**

- INFORMATION IN THIS DOCUMENT IS SUBJECT TO CHANGE WITHOUT NOTICE.
- THE INFORMATION CONTAINED HEREIN IS TO BE CONSIDERED FOR REFERENCE ONLY.

# Table of Contents

---

<b>Chapter 1 Introduction</b> .....	<b>1</b>
1.1 Package Content .....	1
1.2 Features and Specifications.....	1
1.3 Front Panel .....	2
1.4 Back Panel .....	5
1.5 Setting Up the DVR Unit.....	6
1.5.1 Installing the Removable Hard Disk .....	6
1.5.2 Install Internal SATA Hard Disk.....	8
1.5.3 Connecting Devices .....	10
1.5.4 Sensor, Relay and RS485 pinhole allocation .....	11
1.5.4.1 Sensor Pin Definition .....	11
1.5.4.2 Relay Pin Definition .....	11
1.5.4.3 RS485 Pin Definition.....	12
<b>Chapter 2 Operating the EB5416DVD Pro</b> .....	<b>13</b>
2.1 Familiarizing the Remote Control Buttons .....	13
2.1.1 Using USB Backup Button .....	15
2.1.2 Using AB Repeat Function .....	16
2.1.3 Controlling PTZ Camera.....	17
2.1.3.1 To Enter the PTZ Mode.....	17
2.1.3.2 To Set Preset Position .....	17
2.1.3.3 To Control PTZ Camera.....	18
2.2 Using the DVR for the First Time .....	18
2.2.1 Set up the System Date and Time.....	18
2.3 Surveillance Screen.....	19
2.4 Playback the Video .....	21
<b>Chapter 3 OSD Navigation Tree</b> .....	<b>23</b>
3.1 Menu Function.....	24
<b>Chapter 4 Using the USB Playback Console</b> .....	<b>43</b>
4.1 Recommended system requirements .....	43
4.2 Installing the USB Playback Console.....	43
4.3 Running the USB Playback Console .....	44
4.3.1 To Cut and Save the Portion of the Recorded Video.....	46
4.3.2 Playback DVR Recorded File from Hard Disk.....	46
4.3.3 Playback Backup File(*.dvr) .....	47
4.3.4 Playback Backup File (*.avf) .....	47
<b>Chapter 5 Backup Recorded Video File</b> .....	<b>48</b>
5.1 Recommended system requirements .....	48

5.2	Familiarizing with HDD Backup Application .....	48
5.3	To Backup Recorded Video File.....	49
<b>Chapter 6</b>	<b>ImageVerification .....</b>	<b>51</b>
6.1	To Run the ImageVerification.....	51
<b>Chapter 7</b>	<b>iEnhance.....</b>	<b>52</b>
7.1	To Use iStable.....	53
<b>Chapter 8</b>	<b>Using the Remote Programs.....</b>	<b>54</b>
8.1	Familiarizing the Web Viewer Buttons .....	55
8.1.1	To Setup Remote System Setting .....	57
8.1.1.1	System Setup .....	57
8.1.1.2	Camera Setup .....	59
8.1.1.3	Record Setup.....	60
8.1.1.4	Alarm/Sensor Setup.....	61
8.1.1.5	Network Setup .....	63
8.1.1.6	User Setting .....	65
8.2	Familiarizing the Remote Console Buttons.....	66
8.2.1	To Setup Remote Console Setting .....	67
8.3	Familiarizing the WebViewer PTZ Buttons.....	68
8.4	Using the Remote Playback .....	68
8.4.1	Familiarizing the Local Playback Buttons.....	70
8.4.1.1	To Cut and Save the Wanted Portion of the Recorded Video .....	71
8.4.2	Familiarizing the Download and Playback Buttons.....	72



# Chapter 1 Introduction

## 1.1 Package Content



(1)



(2)

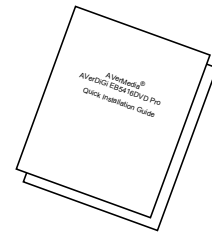

(3)



(4)

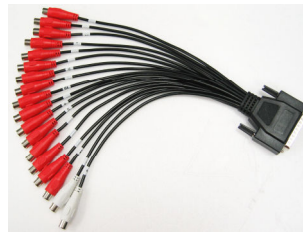

(5)

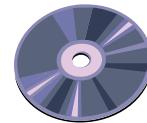

(6)



(7)



(8)

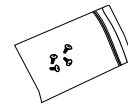

(9)

- (1) EB5416DVD Pro unit
- (2) Remote Control (batteries included)
- (3) Quick Installation Guide
- (4) Power Cord
- (5) Audio cable
- (6) Software CD (User Manual included)
- (7) Extended IR Sensor cable
- (8) Internal HDD holder
- (9) 4 \* screws for internal HDD installation

\* The power cord varies depending on the standard power outlet of the country where it is sold.

## 1.2 Features and Specifications







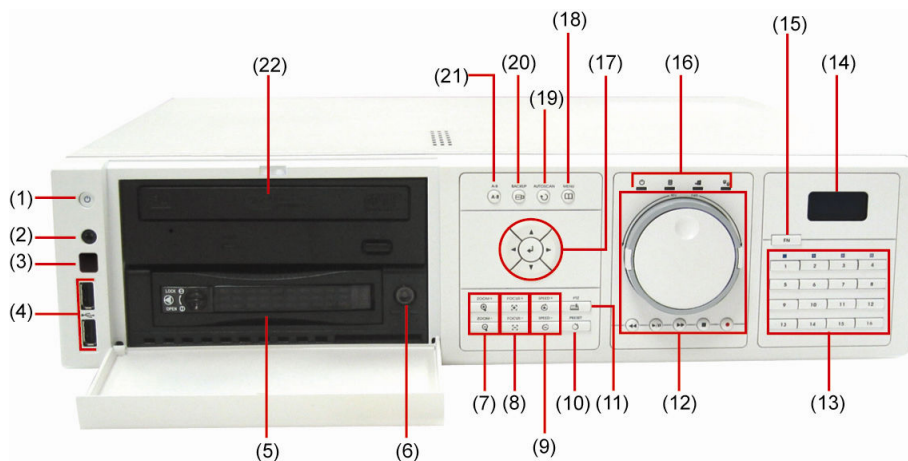













- 16CH composite video input and 16CH loop output
- 1CH Analog Spot monitor
- 16CH Audio In and 2CH Audio Out
- Video compression: MPEG4
- Multi-Quad for display and playback simultaneously
- Hot-key on remote controller for auto save setting
- Full function mouse control from front panel USB port
- Copy camera setting to other channels
- Camera name setting (up to 12 English letters)
- Status bar and camera name on/off
- 16CH Sensor in and 4CH Relay out
- Pre-recording function



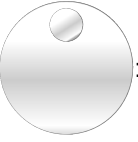







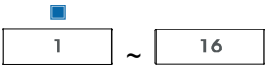













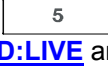
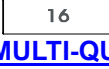

- 3 level password authentication mechanism
- DVD backup (up to 4.2GB)
- Support 2 HDD backup (up to 1.5TB)
- JavaViewer on mobile phone and PDAViewer supported
- Built-in player to playback video without installing CD on PC
- Remote playback and backup
- Jog/Shuttle for playback
- On Screen Display(OSD) control menu
- Support network time synchronize function (Auto correction time delay & Day light saving)
- Support WebViewer on Internet Explorer
- Support Central Management System(CMS)
- Support remote console
- Support USB backup to pen drive and external hard disk
- Support network, playback, and recording simultaneously
- Supports 1 hard disk drive (not included)
- Full-screen resolution:  
Display: 720 x 480 (NTSC) / 720 x 576 (PAL)  
Recording: 720 x 480 (NTSC) / 720 x 576 (PAL)
- Dual VGA and TV display resolution:  
VGA: 800 x 600 / 1024 x 768 / 1280 x 960 / 1280 x 1024  
VGA: 3D de-interlaced engine for best VGA quality
- Recording frame rate:  
**D1 mode:** 60fps (NTSC) / 50fps (PAL)  
**CIF mode:** 120 fps (NTSC) / 100fps (PAL)
- Scheduled recording (00:00~23:00 set by hour and week )
- Search for recorded video files by date/time/event
- Support daylight saving and network time synchronize
- Multiple language operation screens

### 1.3 Front Panel

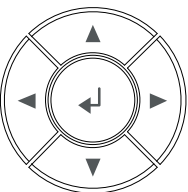

Name	Function
(1) Power	ON/OFF DVR unit
(2) IR Sensor	Receive signal from the remote control to operate the DVR unit

Name	Function
(3) USB 2.0 port	2 x USB 2.0 ports for connecting any USB devices, ex: USB pen drive, external hard disk, keyboard, mouse...and so on.
 Do Not plug in two USB storage devices at the same time.	
(4) Removable Hard Disk Draw	To install hard disk for storage recorded video file
 For hard disk spec, please referring to <a href="http://www.avermedia.com/nvd/hardware-recom_eb_c.asp">http://www.avermedia.com/nvd/hardware-recom_eb_c.asp</a>	
(5) Removable Hard Disk Power	Removable hard disk power switch
(6) Zoom + / Zoom -	 To zoom in view of PTZ camera lens
	 To zoom out view of PTZ camera lens
(7) Focus + / Focus -	 To focus in PTZ camera lens
	 To focus out PTZ camera lens
(8) Speed + / Speed -	 To speed up movement of PTZ camera lens
	 To speed down movement of PTZ camera lens
(9) PTZ Save	 To save the preset position of PTZ camera. Adjust the PTZ camera lens to the position that user wants, and then press  + number button (1~9) to save the preset position. (see also <a href="#">Chapter 2.1.3.2</a> )
	When the PTZ camera in PTZ mode, press preset position number button to move the PTZ camera to preset position.
 Without setup preset position, the preset button (  ) will not be functional when user presses.	
(10) PTZ	 + number button to switch to the certain PTZ camera view
Playback control button in playback mode	
(11) Playback button	 : Speed shuttle for adjusting reversed and forward (2x, 4x, 8x or 16x) speed during playback. Turn left is reversed and turn right is forwarded.
	 : To move to next or previous frame during playback. Turning left is to go back to one previous frame and turning right is to go forward one frame..
 : To reverse at speed of 2x, 4x, 8x, or 16x  : To temporary stop playback or play the recorded video  : To fast forward at speed of 2x, 4x, 8x or 16x  : To stop playback  : To start recording	

Name	Function
(12) Number button	 <ul style="list-style-type: none"> <li>- As a number key for entering password in playback and preview mode</li> <li>- Channel camera selection number in playback and preview mode</li> <li>- As a preset position with  in PTZ control mode</li> <li>- With  button can switch to different screen display modes</li> </ul>
(13) LCD Display	Display DVR system status such as temperature and operate status
(14)	 <p>A functional key for multiple system control</p> <ul style="list-style-type: none"> <li>- Press  to enable multiple function modes and the  button will light up blue.</li> <li>- To exit multiple function modes, press  again.</li> </ul> <p> +  : Switch to single screen display mode</p> <p> +  : Switch to QUAD display mode</p> <p> +  : Switch to 9 spilt screen display mode</p> <p> +  : Switch to 16 spilt screen display mode</p> <p> +  ~  : User defined display mode(see also <a href="#">MULTI-QUAD:LIVE</a> and <a href="#">MULTI-QUAD:Play</a> in Chapter 3)</p>
(15) Status LEDs	<p>system status indicators:</p> <p> : System power indicator. Indicate running state of system. Lights when the system is running.</p> <p> : Removable hard disk indicator. Indicate running state of the hard disk. Lights when the HDD is running</p> <p> : Recording status indicator. Lights when the system is recording.</p> <p> : Network status indicator. Lights when the system network connection is enabled.</p>
(16)	 <ul style="list-style-type: none"> <li>- <b>In OSD mode:</b> Move selection to left, right, up, and down</li> <li>- <b>In PTZ mode:</b> To move PTZ camera lens to left, right, up and down</li> </ul> <p> Confirm or make a selection</p>
(17)	 To call out OSD menu
(18)	 To start auto scan
(19)	 To start USB backup
(20)	 AB Repeat function allow user to set a video segment from A to B point and play on the surveillance screen until user stop. User also can backup AB Repeat file to pen drive or external hard disk (see also <a href="#">2.1.1</a> ).
(21) DVR-ROM	To backup the recorded file to DVD+RW disk

## 1.4 Back Panel

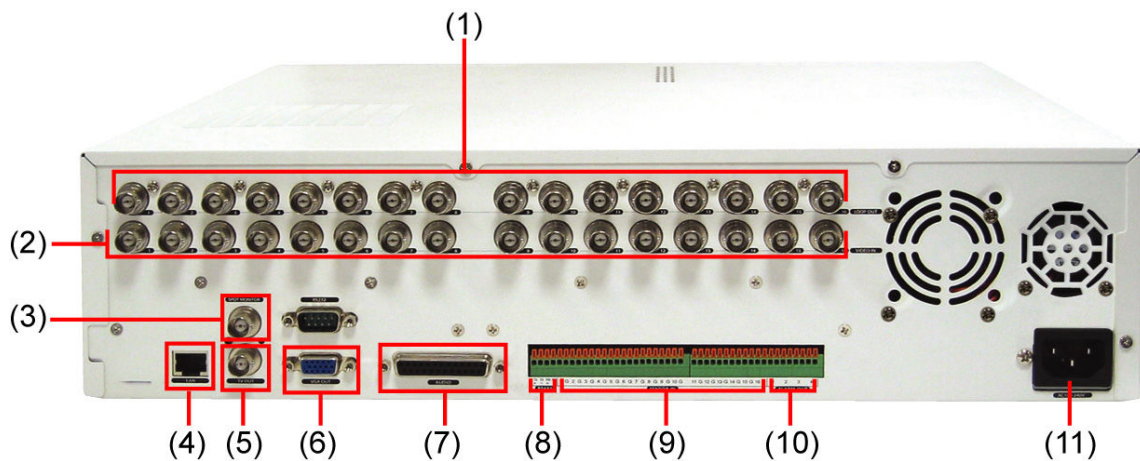

Name	Function
(1) Video Loop Out	Output the video signal to a CCTV monitor. Only output one channel signal at a time.
(2) CH1~ 16	Input the video camera signal and display it on channel 1~ 16
(3) Spot Monitor	Output a video signal to a Spot Monitor when an alarm event is coming
(4) LAN Port	For Ethernet connection
(5) TV Out	Output the video signal to a TV
(6) VGA Out	Output the video signal to a CRT or LCD monitor
(7) Audio I/O	Support 16 channels audio input (ex. Microphone) and 2 channels of audio output(ex. Speaker)
<p><b>i</b> The audio input device needs to be powered by external power.</p>	
(8) RS485	For PTZ camera connection (also see <a href="#">1.5.3</a> )
(9) Sensor In	Support up to 16 sensor devices
(10) Alarm Out	Support 4 relay devices (Relay: 1A @ 125V AC/30V DC)
(11) Power Plug	Connect the power cord into this port

## 1.5 Setting Up the DVR Unit

### 1.5.1 Installing the Removable Hard Disk

The DVR unit allows user to install one hard disk. Before installing the hard disk, make sure to set the hard disk master jumper setting. Adjust the jumper setting according to the instructions on the hard disk label.



For hard disk spec, please referring to [http://www.avermedia.com/nvd/hardware-recom\\_eb.asp](http://www.avermedia.com/nvd/hardware-recom_eb.asp)



The “compatible hard disks” indicated in the above recommendation list only means that these commercially available hard disks were tested with AVerMedia® products and functioned well under normal operation conditions. AVerMedia® does not guarantee or provide warranties, explicitly, implied or statutory with respect to the reliability of the hard disk function or its compatibility. In no event AVerMedia® shall be liable for damages, with respect to any business interruption of clients, lost profits, loss of programs or other data on your information handling system or otherwise. This includes direct, indirect, incidental, special, or consequential damages, resulting from the incompatibility caused by the usage of these hard disks, even if AVerMedia® has expressly advised about the risk of such damages. The entire risk arising out of the use of any information attached here with is borne by the recipient.

Follow the illustrated instructions below to install the hard disk:

1. Unlock the removable hard disk drawer



2. Open the removable hard disk drawer



3. And then, pull out the removable hard disk drawer



4. Remove the removable hard disk drawer cover



5. Carefully insert the hard disk in the removable rack



6. Turn the removable hard disk drawer over and screw hard disk with screws

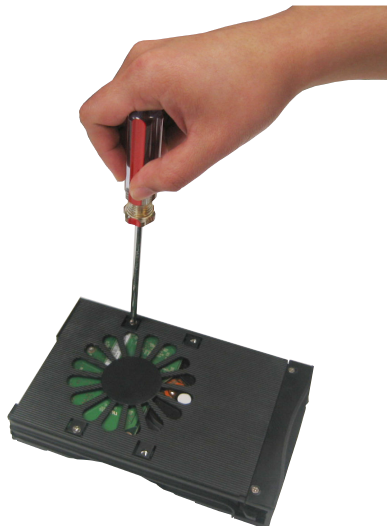

7. And then, close the removable hard disk drawer cover



8. Slide the drawer back cover



9. Lock the removable hard disk drawer keylock



10. Power on the removable hard disk drawer



11. You may now connect all the cables. When the power is connected, the Power LED light turns on

## 1.5.2 Install Internal SATA Hard Disk

User can install one SATA hard disk inside the DVR unit if it is necessary. Please follow the below steps to install the hard disk.

1. Loosen all screws

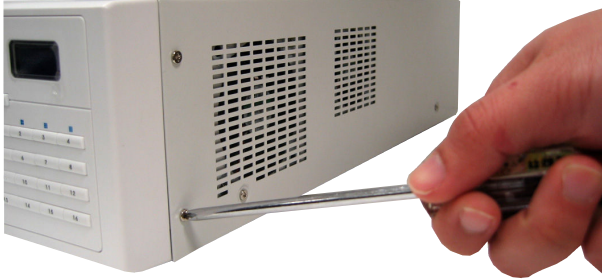

2. Push the cover backward and lift

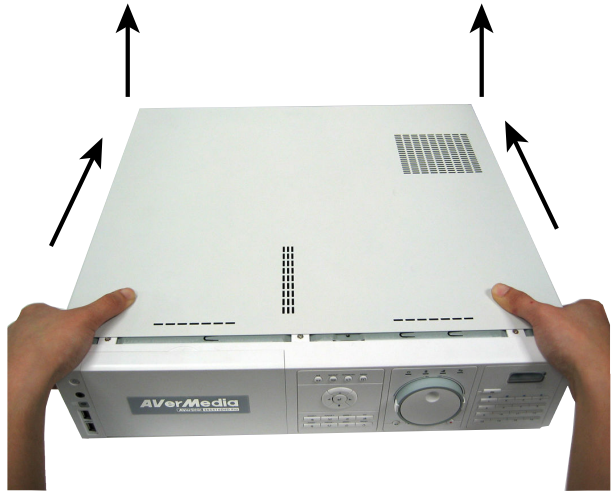

3. Loosen the screws of holder that will make installation more convenient

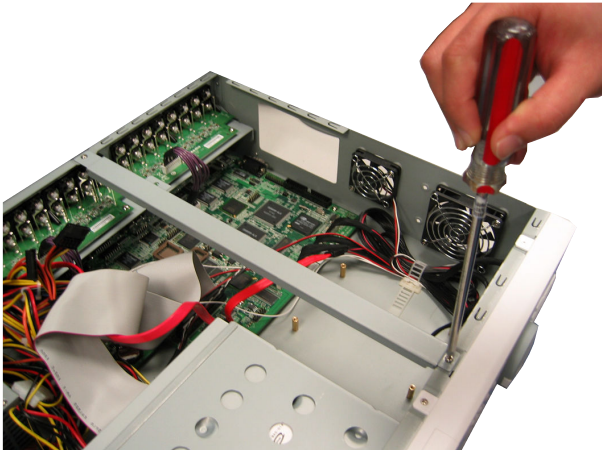

4. Secure the brackets on the hard disk both side



5. Plug the SATA cable into hard disk



6. Plug the power cable into hard disk



7. Secure the hard disk inside the unit

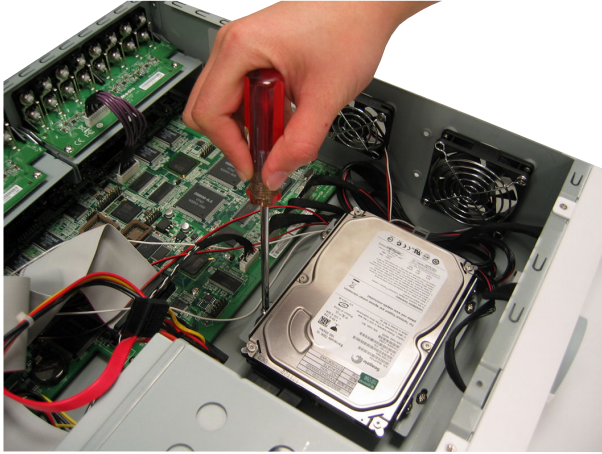

8. Screw tight the holder

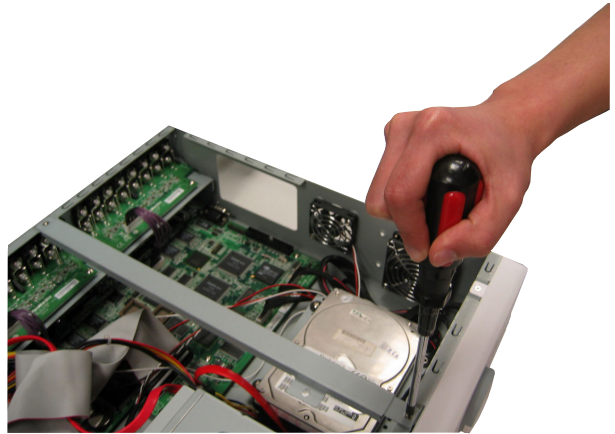

9. Push the cover forward



10. Secure the cover



### 1.5.3 Connecting Devices

The back panel of the DVR unit, user can connect up to 16 video cameras, 16 sensor devices, 4 alarm devices, PTZ camera and output video to a TV or CRT/LCD monitor. Connecting the unit to a pen drive or external hard disk through USB connection for backup, then use the bundled software enables user to transfer, playback and segment the video. Follow the illustration below to make the connection:

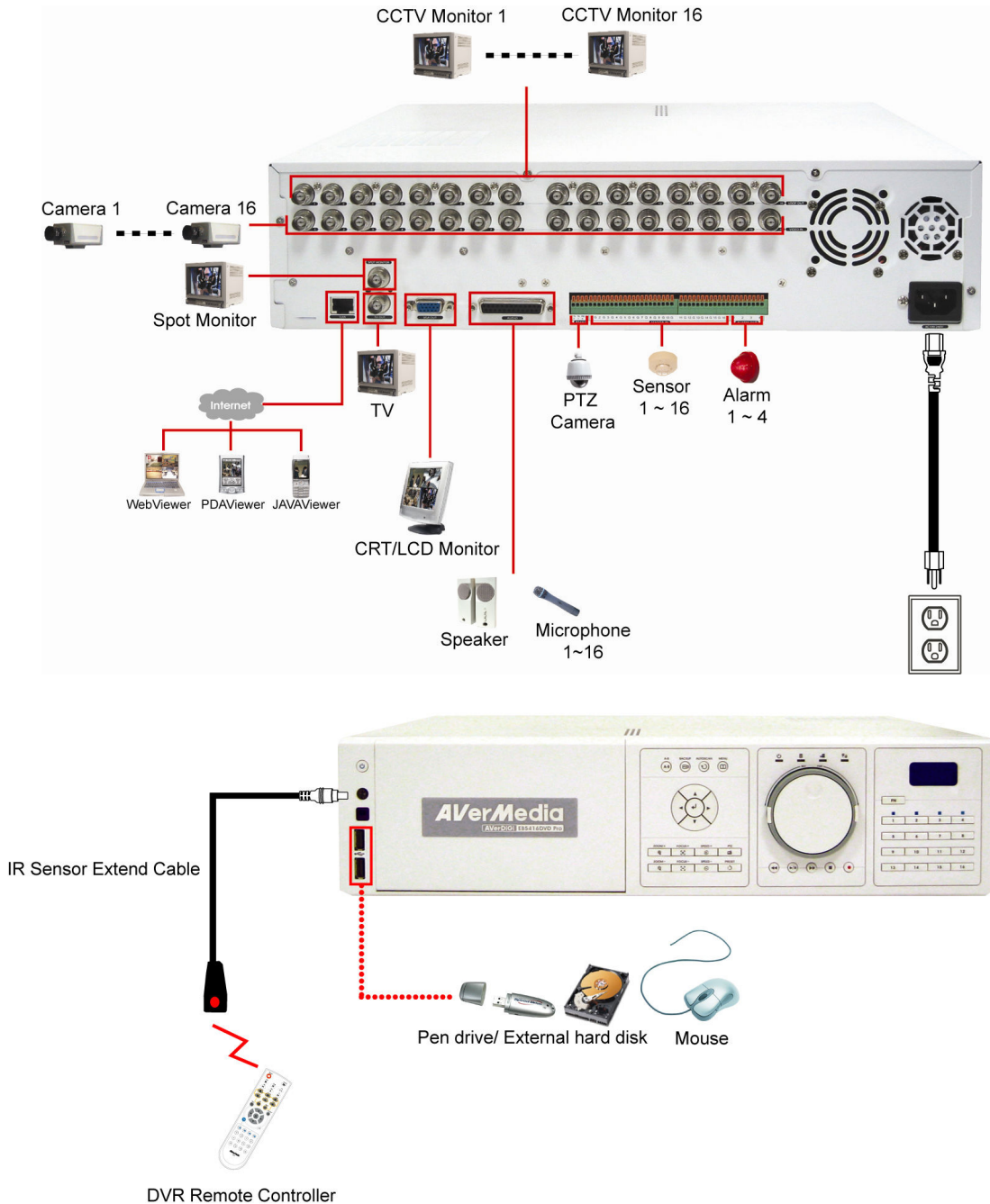

Each time you change the video display output, the power must be turned **off** and **on** to reset the DVR unit.



- All connected devices need to be powered by external power.
- Do Not plug in two USB storage devices at the same time.

## 1.5.4 Sensor, Relay and RS485 pinhole allocation

The Sensor, Alarm, and PTZ camera ports enable you to connect 16 sensor inputs, 4 relay outputs, and 1 PTZ camera. Just connect the external sensor, relay, and PTZ camera pin directly to the pinhole. Check the table below and locate which pinhole is assigned to sensor input and relay output.

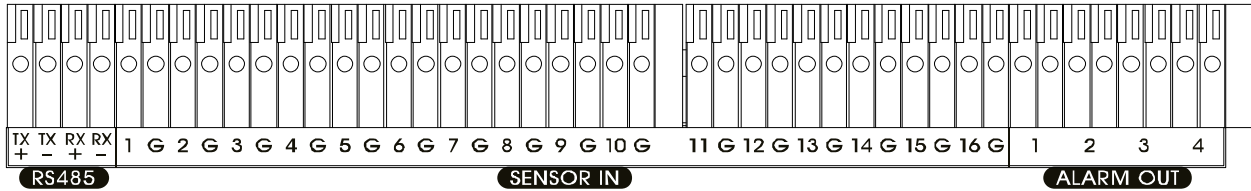

### 1.5.4.1 Sensor Pin Definition

Sensor Pin #	Definition	Sensor Pin #	Definition
1	Sensor 1 signal	9	Sensor 9 signal
G	Sensor 1 ground	G	Sensor 9 ground
2	Sensor 2 signal	10	Sensor 10 signal
G	Sensor 2 ground	G	Sensor 10 ground
3	Sensor 3 signal	11	Sensor 11 signal
G	Sensor 3 ground	G	Sensor 11 ground
4	Sensor 4 signal	12	Sensor 12 signal
G	Sensor 4 ground	G	Sensor 12 ground
5	Sensor 5 signal	13	Sensor 13 signal
G	Sensor 5 ground	G	Sensor 13 ground
6	Sensor 6 signal	14	Sensor 14 signal
G	Sensor 6 ground	G	Sensor 14 ground
7	Sensor 7 signal	15	Sensor 15 signal
G	Sensor 7 ground	G	Sensor 15 ground
8	Sensor 8 signal	16	Sensor 16 signal
G	Sensor 8 ground	G	Sensor 16 ground

### 1.5.4.2 Relay Pin Definition

Pin #	Definition
1	Relay signal
2	Relay signal
3	Relay signal
4	Relay signal

### 1.5.4.3 RS485 Pin Definition

When connect PTZ camera through RS485 interface, please refer to the following pin definition to connect the DVR and PTZ.

<b>Pin #</b>	<b>DVR</b>	<b>PTZ</b>
<b>TX+</b>	RS485 TX+ signal	RS485 RX+ signal
<b>TX-</b>	RS485 TX- signal	RS485 RX- signal
<b>RX+</b>	RS485 RX+ signal	RS485 TX+ signal
<b>RX-</b>	RS485 RX- signal	RS485 TX- signal







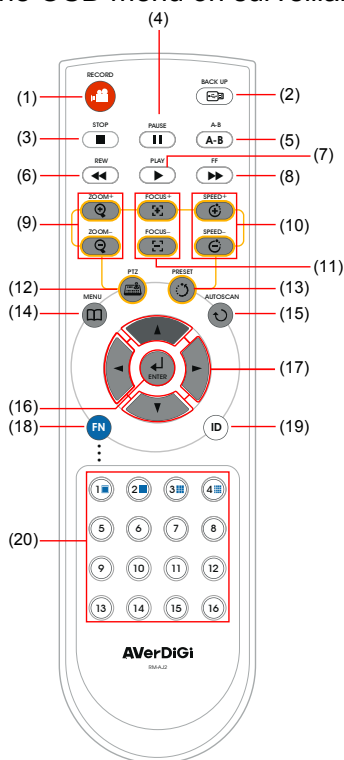









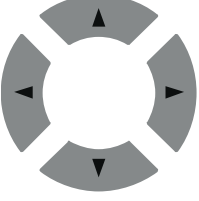











# Chapter 2 Operating the EB5416DVD Pro





















## 2.1 Familiarizing the Remote Control Buttons

Use the Remote control to operate the OSD menu on surveillance screen.





Name	Function
(1)	To start recording video
(2)	USB backup(see <a href="#">2.1.1</a> )
(3)	Stop playing / Stop recording
(4)	To pause playing
(5)	Set a playing recorded video from A point to B point segment and repeat playing on surveillance screen(See <a href="#">2.1.2</a> )
(6)	Decrease the video playback at the speed of 2x, 4x, 8x, or 16x
(7)	Fast play the video playback at the speed of 2x, 4x, 8x, or 16x
(8)	To play the video
(9)	To zoom in view of PTZ camera
	To zoom out view of PTZ camera
(10)	To speed up movement of PTZ camera lens
	To speed down movement of PTZ camera lens
(11)	To focus in PTZ camera lens
	To focus out PTZ camera lens
(12)	To enter PTZ mode

Name	Function
(13) 	<p>To save the preset position of PTZ camera. Adjust the PTZ camera lens to the position that user wants, and then press  + number button ( ~ ) to save the preset position. (see also <a href="#">Chapter 2.1.3.2</a>)</p> <p>When the PTZ camera in PTZ mode, press preset position number button to move the PTZ camera to preset position.</p>
(14) 	To enter the OSD Main menu / Exit from the main menu or sub-menu display
(15) 	To enable the auto scan function
(16) 	Confirm or make a selection
(17) 	<p> To move the selection to the left To move PTZ camera to left</p> <p> To move the selection to the right To move PTZ camera to right</p> <p> To go up and select the items in the menu list or change the settings To move PTZ camera to up</p> <p> To go down and select the items in the menu list or change the settings To move PTZ camera to down</p>
(18) 	<p>A functional key for multiple system control</p> <ul style="list-style-type: none"> <li>- Press  to enable multiple function modes and the  button will turn to blue light.</li> <li>- To exit multiple function modes, press  again.</li> </ul> <p> +  : Switch to single screen display mode</p> <p> +  : Switch to QUAD display mode</p> <p> +  : Switch to 9 split screen display mode</p> <p> +  : Switch to 16 split screen display mode</p> <p> +  ~  : Screen display mode can be defined by user (see also <a href="#">Multi-Quad : Live</a> &amp; <a href="#">Mutli-Quad:play</a> in Chapter 3)</p> <p> +  : Switch the different on screen information display (channel name, date, time, hard disk usage). There 4 type of on screen information display:</p> <ul style="list-style-type: none"> <li>■ Display all (channel name, date, time hard disk, hard disk usage)</li> <li>■ No channel name display</li> <li>■ Display channel name only</li> <li>■ None</li> </ul>



Name	Function
(19) ID	To enter the DVR ID number that assigned by user for multiple DVR controlling ( see also Multiple DVR & DVR ID in Chapter 3) Press ID +  can unselect all DVR
(20)     	- Channel camera selection number in playback and preview mode - As preset positions that work with  in PTZ control mode - With  button can switch to different screen display modes)
   	
   	
   	

## 2.1.1 Using USB Backup Button

User can press  button to backup the AB Repeat video file.

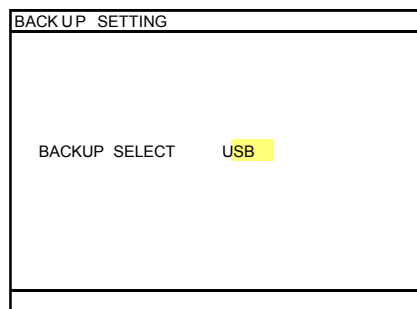
1. Set the AB Repeat file (see [2.1.2](#)).
2. Plug in pen drive, external hard disk to DVR system or place DVD+RW disk into DVD-ROM
3. During the AB Repeat playback, press  button.
4. Select the backup mode – USB or DVD+RW



5. And then, press  to start backup file. To cancel backup, press  to exit backup mode.

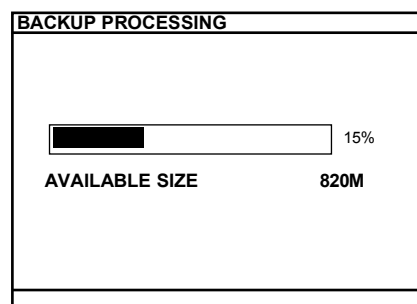

6. When backup process is done, press any key to exit the backup mode.

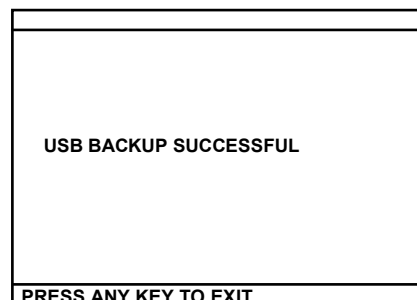



The external hard disk needs to be powered by external power.

## 2.1.2 Using AB Repeat Function

AB Repeat function allow user to set a video segment from A to B point and play on the surveillance screen until user stop. User also can backup AB Repeat file to pen drive or external hard disk (See [2.1.1](#)).



1. Press (play button) to call out the **PLAYBACK** menu to find the recorded video that user wants to playback.
2. Select **TIME SEARCH** or **EVENT LIST**.
  - **TIME SEARCH** (search by date and time): select the date and time from where you want to begin the video playback.
  - **EVENT LIST** (search by condition): select from the list.
3. During the playback, press to set the A point of video segment. And then, press again to set the B point of video segment. On the surveillance screen will display “A-B” and repeat playing the AB point video segment which user has set. To cancel AB repeat, press again.



## 2.1.3 Controlling PTZ Camera

Using remote control, user can easily control PTZ camera at local site. Before starting, please go to OSD menu to enable PTZ control (see [3.1 Menu Function: PTZ Setup](#)).



### 2.1.3.1 To Enter the PTZ Mode









To control PTZ camera, user need to enter the PTZ mode first. Press  button, and camera channel number button ( ~ ) that the selected channel will switch to PTZ mode in a full screen display.



To exit PTZ mode, press . Also, the system will automatically exit PTZ mode when the idle time is over 1 minute.











### 2.1.3.2 To Set Preset Position

User can set 16 preset positions for PTZ camera. Using  +  to  button to set the preset position.



1. Press  and camera channel number button ( ~ ) to enter PTZ mode.
2. Using , ,  and  to adjust the PTZ camera to the position that user wants.
3. Press  to save
4. To move the PTZ camera to preset position, just press the number button.

### 2.1.3.3 To Control PTZ Camera

To move, adjust focus, and zoom in/out camera lens can be done by using some function buttons on the remote control.

-  To move the PTZ camera lens to the right
-  To move the PTZ camera lens to the left
-  To move the PTZ camera lens to go up
-  To move the PTZ camera lens to go down
-  To zoom in PTZ camera
-  To zoom out PTZ camera
-  To speed up movement of PTZ camera lens
-  To speed down movement of PTZ camera lens
-  To focus in PTZ camera lens
-  To focus out PTZ camera lens





## 2.2 Using the DVR for the First Time

Upon connecting the power, the unit automatically detects the status of the hard disk. The hard disk must be formatted before user can use it with EB5416DVD Pro. If you are prompt to format the hard disk, press  (select) for **YES** to format the hard disk and  (menu) for **NO** to remain unchanged.





HARD DISK INFORMATION	
HDD1 FORMAT INVALID	
HDD 1 SIZE	953,669 MB
HDD 1 FORMAT ?	
HDD2 NOT FOUND	
HDD2 SIZE	0 MB
YES (ENTER / S<), NO (MENU / S<)	

### 2.2.1 Set up the System Date and Time







Before starting record video, adjust the date and time first.









- Press  to call up the OSD menu and then use  and  to go up and down and select **SYSTEM**. And then, press  or  to confirm the selection.

TIME SETUP	
<b>DATE FORMAT</b>	YYYY/MM/DD
DATE	2008 / 03 / 12 WED
TIME	21 : 07 : 45
AUTO SYNC TIME	OFF
TIME ZONE	GMT
LAST SYNC TIME	2008 / 01 / 01 00 : 00 : 00
DAYLIGHT SAVING	

- In **SYSTEM**, use  and  to go up and down and select the **TIME SETUP** and press  to make a selection. And then, use  and  to select the **DATE FORMAT** and

press  or  to confirm the selection.



3. To select the format of date, Press  or  and use  and  buttons to change the date format. Press  or  to confirm the selection.

4. After selected the date format, use  and  to go up and down and select the **DATE** and press  or  to confirm. Use  and  buttons to adjust the date. Press  or  to confirm the selection.

5. To adjust **TIME**, follow the above step 3 or 4.

6. Press  to go back to main menu.

## 2.3 Surveillance Screen

To know if the channel is being recorded, the “●” record symbol would appear beside the channel number. The  (microphone) and  (speaker) indicate that the audio is available. The  (motion record) indicate that the channel is in motion record mode. The information below the screen shows the current date and time, hard disk drive, and the percentage of the used hard disk space.



### Preview Mode

In full screen preview, press  +  ~  can switch to different screen display mode.

In Playback mode, the **A-B** (AB Repeat) indicate that playback is in AB repeat status. The **▶**(Play) indicate that DVR unit is playback recorded video.



### Playback Mode





The EB5416DVD Pro supports mouse control that user can use mouse (the middle button of mouse) to click channel to switch between preview and playback mode. To switch back, click channel with middle button of mouse again. Click right mouse button on screen to call out the OSD menu. Use the roller button to select items (user can use left mouse button to click the selection, too) and change selection in OSD menu. To confirm the selection in OSD menu, click left mouse button. To exit current screen, click right mouse button.



### Preview and Playback Simultaneously



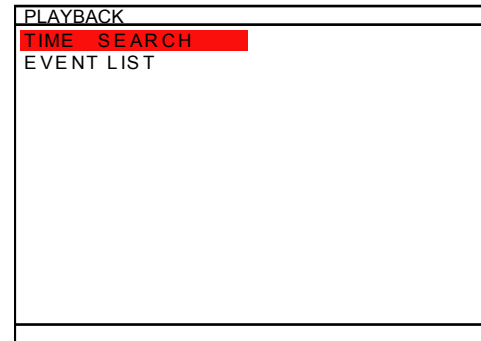

## 2.4 Playback the Video

The DVR system can record and playback video simultaneously. Therefore, user doesn't need to stop recording while playback the video.







1. Press 
2. Use  and  buttons to go up and down and select **TIME SEARCH** or **EVENT LIST**. Then, press  or  to make a selection.

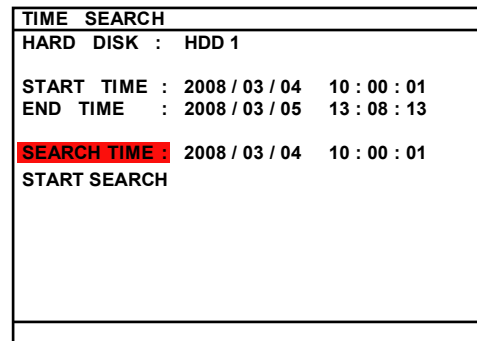





### TIME SEARCH (search by date and time):



1. Use  and  buttons and select **SEARCH TIME**. Then press  or  again to make the selection.
2. In the **SEARCH TIME**, user may now select the date and time from where you want to begin the video playback.







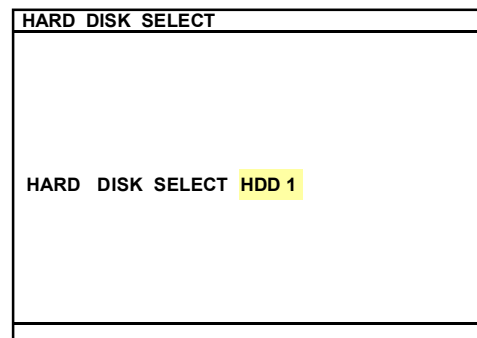

Use  and  buttons to move the selection to the left and right. Use  and  buttons to select the date and time. Then press  or  again to make the selection.

3. To start video playback, the time in second must be set. Use the  buttons to move the selection to the right most. Use  and  buttons and select the time in second. Then press  or .

### EVENT LIST (search by event):

1. Select hard disk drive (HDD1 or HDD2). Use  and  buttons to select it.



2. Use  and  buttons to select from the list. Press  or  again to make the selection. User  and  to go next page or back to previous page.

EVENT LIST				
<input type="checkbox"/>	2008 / 03 / 03	13 : 26 : 34	13 : 26 : 50	A
<input type="checkbox"/>	2008 / 03 / 03	13 : 00 : 01	13 : 16 : 46	B
<input type="checkbox"/>	2008 / 03 / 03	12 : 00 : 01	13 : 00 : 01	M
<input type="checkbox"/>	2008 / 03 / 03	11 : 48 : 37	12 : 00 : 00	M
<input type="checkbox"/>	2008 / 03 / 03	11 : 30 : 23	11 : 31 : 18	M
<input type="checkbox"/>	2008 / 03 / 03	11 : 29 : 47	11 : 30 : 13	M
<input type="checkbox"/>	2008 / 03 / 03	11 : 28 : 55	11 : 28 : 58	M
<input type="checkbox"/>	2008 / 03 / 03	11 : 28 : 33	11 : 28 : 55	M
<input type="checkbox"/>	2008 / 03 / 03	11 : 25 : 41	11 : 28 : 32	M
<input type="checkbox"/>	: ALWAYS RECORDING			
<input type="checkbox"/>	: MOTION RECORDING			
<input checked="" type="checkbox"/>	: SENSOR RECORDING			

3. Listed below are the following recording conditions:
- A** – Always Recording  
It records non-stop and automatically continue recording when interrupted
  - S** – Sensor Recording  
It records when the sensor has been triggered
  - M** – Motion Recording  
It records when any movement has been detected
  - B** – Button Recording  
It records when the  record button is pressed
4. The “▶” play symbol would appear beside the channel number when you are previewing in playback mode.



To playback the recording files during the daylight saving period; please select **Event List** to find the event that user wants to playback. On the first day and last day of daylight saving only has on record in **Time search**, so user can't find the specific playback file in time search.

# Chapter 3 OSD Navigation Tree



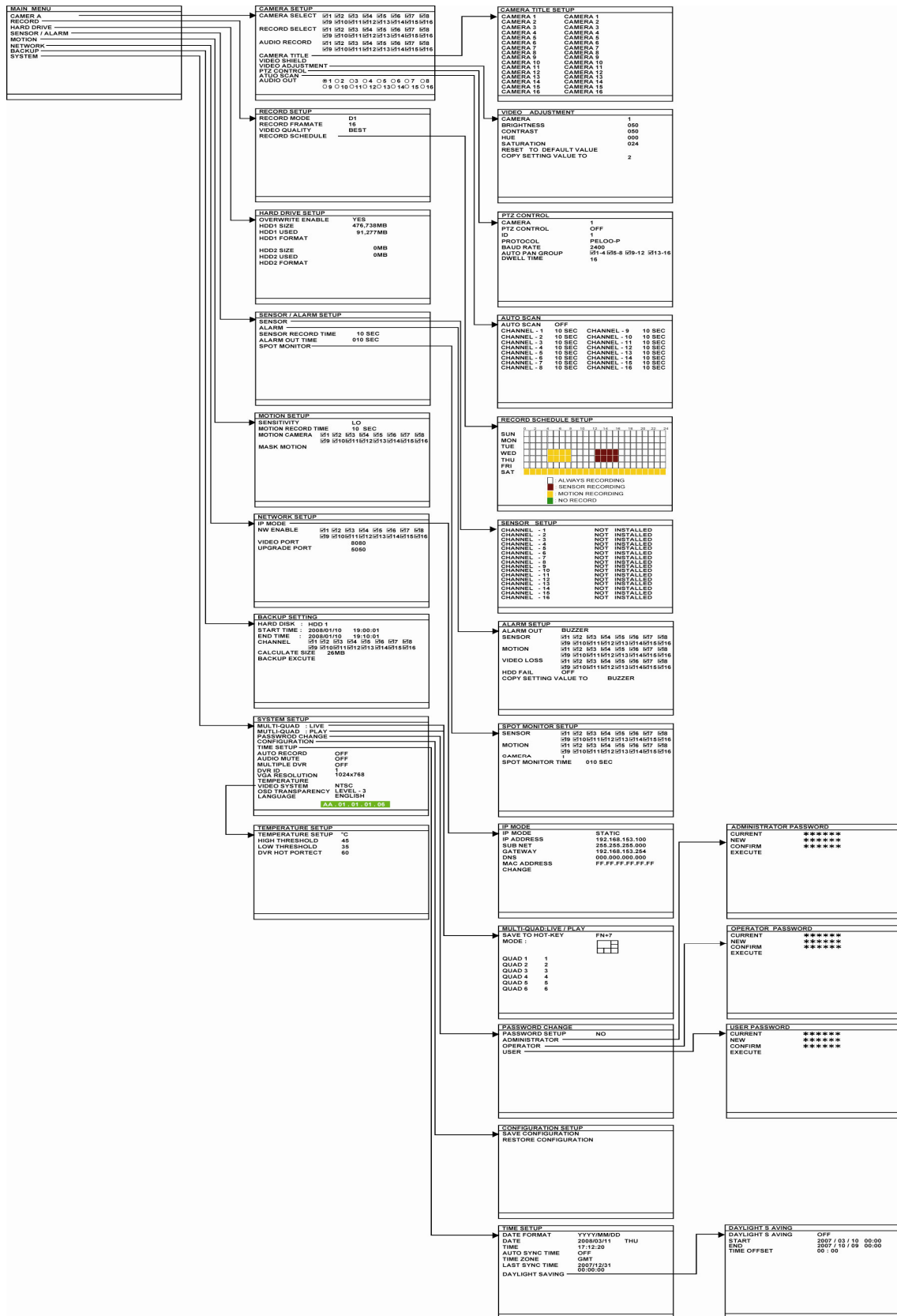

The follow figure is an OSD menu tree map. To call out the OSD menu, press  on the remote control.





## 3.1 Menu Function

If the unit is currently recording the video, user may have to stop video recording to change the settings. User can use the following way to setup DVR unit.

























- Remote Controller
- USB Mouse
- Front Panel control buttons

For using remote controller, use  and  to go up and down the selection list or change the value of selection. Use  and  to move to left and right in the selection list or

item. Use  or  to make a confirmation. Press  to go back previous page or exit from current page.

For using mouse, use right mouse button to call up OSD menu and use left mouse button to make selection. Use middle button (roller) of mouse to change the value of selection or go back to previous page.

\*\*The red frame turns yellow when you are making a selection.

OSD MENU	Description																																														
<table border="1" style="width: 100%;"> <tr><td colspan="2">MAIN MENU</td></tr> <tr><td></td><td>CAMERA</td></tr> <tr><td></td><td>RECORD</td></tr> <tr><td></td><td>HARD DRIVE</td></tr> <tr><td></td><td>SENSOR / ALARM</td></tr> <tr><td></td><td>MOTION</td></tr> <tr><td></td><td>NETWORK</td></tr> <tr><td></td><td>BACKUP</td></tr> <tr><td></td><td>SYSTEM</td></tr> </table>	MAIN MENU			CAMERA		RECORD		HARD DRIVE		SENSOR / ALARM		MOTION		NETWORK		BACKUP		SYSTEM	<p><b>CAMERA</b></p> <p>Select the channel number to display and record the video on the surveillance screen, and enable/disable audio recording. Also, setup cameras name, video shield, PTZ camera, auto scan, audio output and adjust video.</p> <table border="1" style="width: 100%;"> <tr><td colspan="2">CAMERA SETUP</td></tr> <tr><td><b>CAMERA SELECT</b></td><td><input checked="" type="checkbox"/>1 <input checked="" type="checkbox"/>2 <input checked="" type="checkbox"/>3 <input checked="" type="checkbox"/>4 <input checked="" type="checkbox"/>5 <input checked="" type="checkbox"/>6 <input checked="" type="checkbox"/>7 <input checked="" type="checkbox"/>8</td></tr> <tr><td></td><td><input checked="" type="checkbox"/>9 <input checked="" type="checkbox"/>10 <input checked="" type="checkbox"/>11 <input checked="" type="checkbox"/>12 <input checked="" type="checkbox"/>13 <input checked="" type="checkbox"/>14 <input checked="" type="checkbox"/>15 <input checked="" type="checkbox"/>16</td></tr> <tr><td>RECORD SELECT</td><td><input checked="" type="checkbox"/>1 <input checked="" type="checkbox"/>2 <input checked="" type="checkbox"/>3 <input checked="" type="checkbox"/>4 <input checked="" type="checkbox"/>5 <input checked="" type="checkbox"/>6 <input checked="" type="checkbox"/>7 <input checked="" type="checkbox"/>8</td></tr> <tr><td></td><td><input checked="" type="checkbox"/>9 <input checked="" type="checkbox"/>10 <input checked="" type="checkbox"/>11 <input checked="" type="checkbox"/>12 <input checked="" type="checkbox"/>13 <input checked="" type="checkbox"/>14 <input checked="" type="checkbox"/>15 <input checked="" type="checkbox"/>16</td></tr> <tr><td>AUDIO RECORD</td><td><input checked="" type="checkbox"/>1 <input checked="" type="checkbox"/>2 <input checked="" type="checkbox"/>3 <input checked="" type="checkbox"/>4 <input checked="" type="checkbox"/>5 <input checked="" type="checkbox"/>6 <input checked="" type="checkbox"/>7 <input checked="" type="checkbox"/>8</td></tr> <tr><td></td><td><input checked="" type="checkbox"/>9 <input checked="" type="checkbox"/>10 <input checked="" type="checkbox"/>11 <input checked="" type="checkbox"/>12 <input checked="" type="checkbox"/>13 <input checked="" type="checkbox"/>14 <input checked="" type="checkbox"/>15 <input checked="" type="checkbox"/>16</td></tr> <tr><td colspan="2">CAMERA TITLE</td></tr> <tr><td colspan="2">VIDEO SHIELD</td></tr> <tr><td colspan="2">VIDEO ADJUSTMENT</td></tr> <tr><td colspan="2">PTZ CONTROL</td></tr> <tr><td colspan="2">AUTO SCAN</td></tr> <tr><td>AUDIO OUT</td><td><input type="radio"/>1 <input type="radio"/>2 <input type="radio"/>3 <input type="radio"/>4 <input type="radio"/>5 <input type="radio"/>6 <input type="radio"/>7 <input type="radio"/>8</td></tr> <tr><td></td><td><input type="radio"/>9 <input type="radio"/>10 <input type="radio"/>11 <input type="radio"/>12 <input type="radio"/>13 <input type="radio"/>14 <input type="radio"/>15 <input type="radio"/>16</td></tr> </table>	CAMERA SETUP		<b>CAMERA SELECT</b>	<input checked="" type="checkbox"/> 1 <input checked="" type="checkbox"/> 2 <input checked="" type="checkbox"/> 3 <input checked="" type="checkbox"/> 4 <input checked="" type="checkbox"/> 5 <input checked="" type="checkbox"/> 6 <input checked="" type="checkbox"/> 7 <input checked="" type="checkbox"/> 8		<input checked="" type="checkbox"/> 9 <input checked="" type="checkbox"/> 10 <input checked="" type="checkbox"/> 11 <input checked="" type="checkbox"/> 12 <input checked="" type="checkbox"/> 13 <input checked="" type="checkbox"/> 14 <input checked="" type="checkbox"/> 15 <input checked="" type="checkbox"/> 16	RECORD SELECT	<input checked="" type="checkbox"/> 1 <input checked="" type="checkbox"/> 2 <input checked="" type="checkbox"/> 3 <input checked="" type="checkbox"/> 4 <input checked="" type="checkbox"/> 5 <input checked="" type="checkbox"/> 6 <input checked="" type="checkbox"/> 7 <input checked="" type="checkbox"/> 8		<input checked="" type="checkbox"/> 9 <input checked="" type="checkbox"/> 10 <input checked="" type="checkbox"/> 11 <input checked="" type="checkbox"/> 12 <input checked="" type="checkbox"/> 13 <input checked="" type="checkbox"/> 14 <input checked="" type="checkbox"/> 15 <input checked="" type="checkbox"/> 16	AUDIO RECORD	<input checked="" type="checkbox"/> 1 <input checked="" type="checkbox"/> 2 <input checked="" type="checkbox"/> 3 <input checked="" type="checkbox"/> 4 <input checked="" type="checkbox"/> 5 <input checked="" type="checkbox"/> 6 <input checked="" type="checkbox"/> 7 <input checked="" type="checkbox"/> 8		<input checked="" type="checkbox"/> 9 <input checked="" type="checkbox"/> 10 <input checked="" type="checkbox"/> 11 <input checked="" type="checkbox"/> 12 <input checked="" type="checkbox"/> 13 <input checked="" type="checkbox"/> 14 <input checked="" type="checkbox"/> 15 <input checked="" type="checkbox"/> 16	CAMERA TITLE		VIDEO SHIELD		VIDEO ADJUSTMENT		PTZ CONTROL		AUTO SCAN		AUDIO OUT	<input type="radio"/> 1 <input type="radio"/> 2 <input type="radio"/> 3 <input type="radio"/> 4 <input type="radio"/> 5 <input type="radio"/> 6 <input type="radio"/> 7 <input type="radio"/> 8		<input type="radio"/> 9 <input type="radio"/> 10 <input type="radio"/> 11 <input type="radio"/> 12 <input type="radio"/> 13 <input type="radio"/> 14 <input type="radio"/> 15 <input type="radio"/> 16
MAIN MENU																																															
	CAMERA																																														
	RECORD																																														
	HARD DRIVE																																														
	SENSOR / ALARM																																														
	MOTION																																														
	NETWORK																																														
	BACKUP																																														
	SYSTEM																																														
CAMERA SETUP																																															
<b>CAMERA SELECT</b>	<input checked="" type="checkbox"/> 1 <input checked="" type="checkbox"/> 2 <input checked="" type="checkbox"/> 3 <input checked="" type="checkbox"/> 4 <input checked="" type="checkbox"/> 5 <input checked="" type="checkbox"/> 6 <input checked="" type="checkbox"/> 7 <input checked="" type="checkbox"/> 8																																														
	<input checked="" type="checkbox"/> 9 <input checked="" type="checkbox"/> 10 <input checked="" type="checkbox"/> 11 <input checked="" type="checkbox"/> 12 <input checked="" type="checkbox"/> 13 <input checked="" type="checkbox"/> 14 <input checked="" type="checkbox"/> 15 <input checked="" type="checkbox"/> 16																																														
RECORD SELECT	<input checked="" type="checkbox"/> 1 <input checked="" type="checkbox"/> 2 <input checked="" type="checkbox"/> 3 <input checked="" type="checkbox"/> 4 <input checked="" type="checkbox"/> 5 <input checked="" type="checkbox"/> 6 <input checked="" type="checkbox"/> 7 <input checked="" type="checkbox"/> 8																																														
	<input checked="" type="checkbox"/> 9 <input checked="" type="checkbox"/> 10 <input checked="" type="checkbox"/> 11 <input checked="" type="checkbox"/> 12 <input checked="" type="checkbox"/> 13 <input checked="" type="checkbox"/> 14 <input checked="" type="checkbox"/> 15 <input checked="" type="checkbox"/> 16																																														
AUDIO RECORD	<input checked="" type="checkbox"/> 1 <input checked="" type="checkbox"/> 2 <input checked="" type="checkbox"/> 3 <input checked="" type="checkbox"/> 4 <input checked="" type="checkbox"/> 5 <input checked="" type="checkbox"/> 6 <input checked="" type="checkbox"/> 7 <input checked="" type="checkbox"/> 8																																														
	<input checked="" type="checkbox"/> 9 <input checked="" type="checkbox"/> 10 <input checked="" type="checkbox"/> 11 <input checked="" type="checkbox"/> 12 <input checked="" type="checkbox"/> 13 <input checked="" type="checkbox"/> 14 <input checked="" type="checkbox"/> 15 <input checked="" type="checkbox"/> 16																																														
CAMERA TITLE																																															
VIDEO SHIELD																																															
VIDEO ADJUSTMENT																																															
PTZ CONTROL																																															
AUTO SCAN																																															
AUDIO OUT	<input type="radio"/> 1 <input type="radio"/> 2 <input type="radio"/> 3 <input type="radio"/> 4 <input type="radio"/> 5 <input type="radio"/> 6 <input type="radio"/> 7 <input type="radio"/> 8																																														
	<input type="radio"/> 9 <input type="radio"/> 10 <input type="radio"/> 11 <input type="radio"/> 12 <input type="radio"/> 13 <input type="radio"/> 14 <input type="radio"/> 15 <input type="radio"/> 16																																														
	<p><b>CAMERA SELECT</b></p> <p>Select the channel to display the video on the surveillance screen.</p> <p><b>RECORD SELECT</b></p> <p>Enable/disable the channel number to record video</p> <hr/> <p> The channels which could be recorded should be enabled in the <b>CAMERA SELECT</b> first.</p> <hr/> <p><b>AUDIO RECORD</b></p> <p>Enable/disable audio recording. To record sound, make sure the audio input device (ex: microphone) is connected to the DVR unit.</p>																																														

**OSD MENU**

**Description**

CAMERA SETUP	
CAMERA SELECT	<input checked="" type="checkbox"/> 1 <input checked="" type="checkbox"/> 2 <input checked="" type="checkbox"/> 3 <input checked="" type="checkbox"/> 4 <input checked="" type="checkbox"/> 5 <input checked="" type="checkbox"/> 6 <input checked="" type="checkbox"/> 7 <input checked="" type="checkbox"/> 8 <input checked="" type="checkbox"/> 9 <input checked="" type="checkbox"/> 10 <input checked="" type="checkbox"/> 11 <input checked="" type="checkbox"/> 12 <input checked="" type="checkbox"/> 13 <input checked="" type="checkbox"/> 14 <input checked="" type="checkbox"/> 15 <input checked="" type="checkbox"/> 16
RECORD SELECT	<input checked="" type="checkbox"/> 1 <input checked="" type="checkbox"/> 2 <input checked="" type="checkbox"/> 3 <input checked="" type="checkbox"/> 4 <input checked="" type="checkbox"/> 5 <input checked="" type="checkbox"/> 6 <input checked="" type="checkbox"/> 7 <input checked="" type="checkbox"/> 8 <input checked="" type="checkbox"/> 9 <input checked="" type="checkbox"/> 10 <input checked="" type="checkbox"/> 11 <input checked="" type="checkbox"/> 12 <input checked="" type="checkbox"/> 13 <input checked="" type="checkbox"/> 14 <input checked="" type="checkbox"/> 15 <input checked="" type="checkbox"/> 16
AUDIO RECORD	<input checked="" type="checkbox"/> 1 <input checked="" type="checkbox"/> 2 <input checked="" type="checkbox"/> 3 <input checked="" type="checkbox"/> 4 <input checked="" type="checkbox"/> 5 <input checked="" type="checkbox"/> 6 <input checked="" type="checkbox"/> 7 <input checked="" type="checkbox"/> 8 <input checked="" type="checkbox"/> 9 <input checked="" type="checkbox"/> 10 <input checked="" type="checkbox"/> 11 <input checked="" type="checkbox"/> 12 <input checked="" type="checkbox"/> 13 <input checked="" type="checkbox"/> 14 <input checked="" type="checkbox"/> 15 <input checked="" type="checkbox"/> 16
<b>CAMERA TITLE</b>	
VIDEO SHIELD	
VIDEO ADJUSTMENT	
PTZ CONTROL	
AUTO SCAN	
AUDIO OUT	<input type="radio"/> 1 <input type="radio"/> 2 <input type="radio"/> 3 <input type="radio"/> 4 <input type="radio"/> 5 <input type="radio"/> 6 <input type="radio"/> 7 <input type="radio"/> 8 <input type="radio"/> 9 <input type="radio"/> 10 <input type="radio"/> 11 <input type="radio"/> 12 <input type="radio"/> 13 <input type="radio"/> 14 <input type="radio"/> 15 <input type="radio"/> 16





**CAMERA TITLE**

To assign a name for each channel. The maximum inputs is 12 characters that includes letters of the alphabet, +, -, @, /, space, dash, and dot.

CAMERA TITLE SETUP	
<b>CAMERA 1</b>	CH 01
CAMERA 2	CH 02
CAMERA 3	CH 03
CAMERA 4	CH 04
CAMERA 5	CH 05
CAMERA 6	CH 06
CAMERA 7	CH 07
CAMERA 8	CH 08
CAMERA 9	CH 09
CAMERA 10	CH 10
CAMERA 11	CH 11
CAMERA 12	CH 12
CAMERA 13	CH 13
CAMERA 14	CH 14
CAMERA 15	CH 15
CAMERA 16	CH 16

**VIDEO SHIELD**

Select an area that will be blocking for particular security issue when DVR unit is recording such as enter password for entrance guard.

Use the , , , and  buttons to move to the left, right, up, and down. Use the  buttons to select the block area

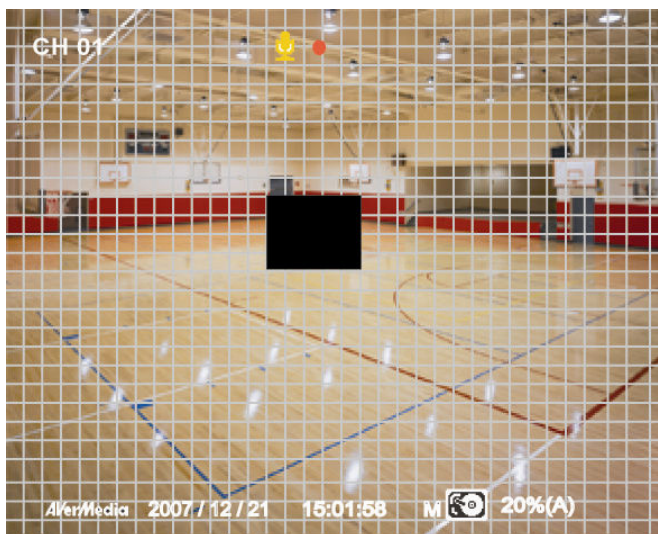

**OSD MENU****Description**

CAMERA SETUP	
CAMERA SELECT	<input checked="" type="checkbox"/> 1 <input checked="" type="checkbox"/> 2 <input checked="" type="checkbox"/> 3 <input checked="" type="checkbox"/> 4 <input checked="" type="checkbox"/> 5 <input checked="" type="checkbox"/> 6 <input checked="" type="checkbox"/> 7 <input checked="" type="checkbox"/> 8 <input checked="" type="checkbox"/> 9 <input checked="" type="checkbox"/> 10 <input checked="" type="checkbox"/> 11 <input checked="" type="checkbox"/> 12 <input checked="" type="checkbox"/> 13 <input checked="" type="checkbox"/> 14 <input checked="" type="checkbox"/> 15 <input checked="" type="checkbox"/> 16
RECORD SELECT	<input checked="" type="checkbox"/> 1 <input checked="" type="checkbox"/> 2 <input checked="" type="checkbox"/> 3 <input checked="" type="checkbox"/> 4 <input checked="" type="checkbox"/> 5 <input checked="" type="checkbox"/> 6 <input checked="" type="checkbox"/> 7 <input checked="" type="checkbox"/> 8 <input checked="" type="checkbox"/> 9 <input checked="" type="checkbox"/> 10 <input checked="" type="checkbox"/> 11 <input checked="" type="checkbox"/> 12 <input checked="" type="checkbox"/> 13 <input checked="" type="checkbox"/> 14 <input checked="" type="checkbox"/> 15 <input checked="" type="checkbox"/> 16
AUDIO RECORD	<input checked="" type="checkbox"/> 1 <input checked="" type="checkbox"/> 2 <input checked="" type="checkbox"/> 3 <input checked="" type="checkbox"/> 4 <input checked="" type="checkbox"/> 5 <input checked="" type="checkbox"/> 6 <input checked="" type="checkbox"/> 7 <input checked="" type="checkbox"/> 8 <input checked="" type="checkbox"/> 9 <input checked="" type="checkbox"/> 10 <input checked="" type="checkbox"/> 11 <input checked="" type="checkbox"/> 12 <input checked="" type="checkbox"/> 13 <input checked="" type="checkbox"/> 14 <input checked="" type="checkbox"/> 15 <input checked="" type="checkbox"/> 16
CAMERA TITLE	
VIDEO SHIELD	
<b>VIDEO ADJUSTMENT</b>	
PTZ CONTROL	
AUTO SCAN	<input type="radio"/> 1 <input type="radio"/> 2 <input type="radio"/> 3 <input type="radio"/> 4 <input type="radio"/> 5 <input type="radio"/> 6 <input type="radio"/> 7 <input type="radio"/> 8 <input type="radio"/> 9 <input type="radio"/> 10 <input type="radio"/> 11 <input type="radio"/> 12 <input type="radio"/> 13 <input type="radio"/> 14 <input type="radio"/> 15 <input type="radio"/> 16
AUDIO OUT	<input type="radio"/> 1 <input type="radio"/> 2 <input type="radio"/> 3 <input type="radio"/> 4 <input type="radio"/> 5 <input type="radio"/> 6 <input type="radio"/> 7 <input type="radio"/> 8 <input type="radio"/> 9 <input type="radio"/> 10 <input type="radio"/> 11 <input type="radio"/> 12 <input type="radio"/> 13 <input type="radio"/> 14 <input type="radio"/> 15 <input type="radio"/> 16

**VIDEO ADJUSTMENT :**

Select the camera number and set to adjust the video brightness, contrast, hue, and saturation value.

To reset the setting, select **RESET TO DEFAULT VALUE**. The video adjustment setting can be copy to reset of cameras by selecting **COPY SETTING VALUE TO** camera #.

VIDEO ADJUSTMEN SETUP	
<b>CAMERA</b>	1
BRIGHTNESS	128
CONTRAST	128
HUE	128
SATURATION	128
RESET TO DEFAULT VALUE	
COPY SETTING VALUE TO	2

CAMERA SETUP	
CAMERA SELECT	<input checked="" type="checkbox"/> 1 <input checked="" type="checkbox"/> 2 <input checked="" type="checkbox"/> 3 <input checked="" type="checkbox"/> 4 <input checked="" type="checkbox"/> 5 <input checked="" type="checkbox"/> 6 <input checked="" type="checkbox"/> 7 <input checked="" type="checkbox"/> 8 <input checked="" type="checkbox"/> 9 <input checked="" type="checkbox"/> 10 <input checked="" type="checkbox"/> 11 <input checked="" type="checkbox"/> 12 <input checked="" type="checkbox"/> 13 <input checked="" type="checkbox"/> 14 <input checked="" type="checkbox"/> 15 <input checked="" type="checkbox"/> 16
RECORD SELECT	<input checked="" type="checkbox"/> 1 <input checked="" type="checkbox"/> 2 <input checked="" type="checkbox"/> 3 <input checked="" type="checkbox"/> 4 <input checked="" type="checkbox"/> 5 <input checked="" type="checkbox"/> 6 <input checked="" type="checkbox"/> 7 <input checked="" type="checkbox"/> 8 <input checked="" type="checkbox"/> 9 <input checked="" type="checkbox"/> 10 <input checked="" type="checkbox"/> 11 <input checked="" type="checkbox"/> 12 <input checked="" type="checkbox"/> 13 <input checked="" type="checkbox"/> 14 <input checked="" type="checkbox"/> 15 <input checked="" type="checkbox"/> 16
AUDIO RECORD	<input checked="" type="checkbox"/> 1 <input checked="" type="checkbox"/> 2 <input checked="" type="checkbox"/> 3 <input checked="" type="checkbox"/> 4 <input checked="" type="checkbox"/> 5 <input checked="" type="checkbox"/> 6 <input checked="" type="checkbox"/> 7 <input checked="" type="checkbox"/> 8 <input checked="" type="checkbox"/> 9 <input checked="" type="checkbox"/> 10 <input checked="" type="checkbox"/> 11 <input checked="" type="checkbox"/> 12 <input checked="" type="checkbox"/> 13 <input checked="" type="checkbox"/> 14 <input checked="" type="checkbox"/> 15 <input checked="" type="checkbox"/> 16
CAMERA TITLE	
VIDEO SHIELD	
VIDEO ADJUSTMENT	
<b>PTZ CONTROL</b>	
AUTO SCAN	<input type="radio"/> 1 <input type="radio"/> 2 <input type="radio"/> 3 <input type="radio"/> 4 <input type="radio"/> 5 <input type="radio"/> 6 <input type="radio"/> 7 <input type="radio"/> 8 <input type="radio"/> 9 <input type="radio"/> 10 <input type="radio"/> 11 <input type="radio"/> 12 <input type="radio"/> 13 <input type="radio"/> 14 <input type="radio"/> 15 <input type="radio"/> 16
AUDIO OUT	<input type="radio"/> 1 <input type="radio"/> 2 <input type="radio"/> 3 <input type="radio"/> 4 <input type="radio"/> 5 <input type="radio"/> 6 <input type="radio"/> 7 <input type="radio"/> 8 <input type="radio"/> 9 <input type="radio"/> 10 <input type="radio"/> 11 <input type="radio"/> 12 <input type="radio"/> 13 <input type="radio"/> 14 <input type="radio"/> 15 <input type="radio"/> 16

**PTZ SETUP**

To enable PTZ camera control by remote control and setup PTZ camera parameters.

PTZ SETUP	
<b>CAMERA</b>	1
PTZ CONTROL	OFF
ID	1
PROTOCOL	PELCO-D
BAUD RATE	2400
AUTO PAN GROUP	<input checked="" type="checkbox"/> 1-4 <input checked="" type="checkbox"/> 5-8 <input checked="" type="checkbox"/> 9-12 <input checked="" type="checkbox"/> 13-16
DWELL TIME	05 SEC

**CAMERA:**

Select the channel of PTZ camera. If the PTZ camera is connecting on channel 1, then select the camera 1 for PTZ video to be display on channel 1.

**PTZ CONTROL:**

To enable/disable PTZ camera can be controlled by remote control at local site.

**ID:**

Assign an ID to PTZ camera. The ID range is from 001 to 255 but is limiting by protocol of PTZ camera. Please refer to your PTZ camera user's manual for more detail of PTZ ID assignment.



We suggest assigning PTZ camera ID star from 5 to avoid conflict with ID of camera channels.

**PROTOCOL:**

Select the protocol of PTZ camera. The protocol will be differenced that depends on the brand of PTZ camera. The DVR system currently supports 3 protocols — PELCO-D, PELCO-P, and CANON VC-C4R. Please refer to your PTZ camera user manual to make sure which protocol is using for.

**OSD MENU**

**Description**

<b>PTZ SETUP</b>	
<b>CAMERA</b>	1
PTZ CONTROL	OFF
ID	1
PROTOCOL	PELCO-D
BAUD RATE	2400
AUTO PAN GROUP	<input checked="" type="checkbox"/> 1-4 <input checked="" type="checkbox"/> 5-8 <input checked="" type="checkbox"/> 9-12 <input checked="" type="checkbox"/> 13-16
DWELL TIME	05 SEC

**BAUD RATE:**

To setup the baud rate of PTZ camera. For more detail, please refer to your PTZ camera's user manual.

**AUTO PAN GROUP:**

Select the preset number to assign an auto move direction for the PTZ camera. For example: 1-4 means the PTZ camera will auto move from preset position 1, 2, 3 to 4.

**DWELL TIME:**

Set a time that how long the PTZ camera stays in that position before it moves to the next one.

<b>CAMERA SETUP</b>	
CAMERA SELECT	<input checked="" type="checkbox"/> 1 <input checked="" type="checkbox"/> 2 <input checked="" type="checkbox"/> 3 <input checked="" type="checkbox"/> 4 <input checked="" type="checkbox"/> 5 <input checked="" type="checkbox"/> 6 <input checked="" type="checkbox"/> 7 <input checked="" type="checkbox"/> 8 <input checked="" type="checkbox"/> 9 <input checked="" type="checkbox"/> 10 <input checked="" type="checkbox"/> 11 <input checked="" type="checkbox"/> 12 <input checked="" type="checkbox"/> 13 <input checked="" type="checkbox"/> 14 <input checked="" type="checkbox"/> 15 <input checked="" type="checkbox"/> 16
RECORD SELECT	<input checked="" type="checkbox"/> 1 <input checked="" type="checkbox"/> 2 <input checked="" type="checkbox"/> 3 <input checked="" type="checkbox"/> 4 <input checked="" type="checkbox"/> 5 <input checked="" type="checkbox"/> 6 <input checked="" type="checkbox"/> 7 <input checked="" type="checkbox"/> 8 <input checked="" type="checkbox"/> 9 <input checked="" type="checkbox"/> 10 <input checked="" type="checkbox"/> 11 <input checked="" type="checkbox"/> 12 <input checked="" type="checkbox"/> 13 <input checked="" type="checkbox"/> 14 <input checked="" type="checkbox"/> 15 <input checked="" type="checkbox"/> 16
AUDIO RECORD	<input checked="" type="checkbox"/> 1 <input checked="" type="checkbox"/> 2 <input checked="" type="checkbox"/> 3 <input checked="" type="checkbox"/> 4 <input checked="" type="checkbox"/> 5 <input checked="" type="checkbox"/> 6 <input checked="" type="checkbox"/> 7 <input checked="" type="checkbox"/> 8 <input checked="" type="checkbox"/> 9 <input checked="" type="checkbox"/> 10 <input checked="" type="checkbox"/> 11 <input checked="" type="checkbox"/> 12 <input checked="" type="checkbox"/> 13 <input checked="" type="checkbox"/> 14 <input checked="" type="checkbox"/> 15 <input checked="" type="checkbox"/> 16
CAMERA TITLE	
VIDEO SHIELD	
VIDEO ADJUSTMENT	
PTZ CONTROL	
<b>AUTO SCAN</b>	
AUDIO OUT	<input type="radio"/> 1 <input type="radio"/> 2 <input type="radio"/> 3 <input type="radio"/> 4 <input type="radio"/> 5 <input type="radio"/> 6 <input type="radio"/> 7 <input type="radio"/> 8 <input type="radio"/> 9 <input type="radio"/> 10 <input type="radio"/> 11 <input type="radio"/> 12 <input type="radio"/> 13 <input type="radio"/> 14 <input type="radio"/> 15 <input type="radio"/> 16

**AUTO SCAN**

Enable/disable auto cycle switch to display the next channel when in full screen preview. User can set different switch time for each channel. The time range is from 1 ~30 seconds.

<b>AUTO SCAN</b>	
<b>AUTO SCAN</b>	OFF
CHANNEL - 1	10 SEC
CHANNEL - 2	10 SEC
CHANNEL - 3	10 SEC
CHANNEL - 4	10 SEC
CHANNEL - 5	10 SEC
CHANNEL - 6	10 SEC
CHANNEL - 7	10 SEC
CHANNEL - 8	10 SEC
CHANNEL - 9	10 SEC
CHANNEL - 10	10 SEC
CHANNEL - 11	10 SEC
CHANNEL - 12	10 SEC
CHANNEL - 13	10 SEC
CHANNEL - 14	10 SEC
CHANNEL - 15	10 SEC
CHANNEL - 16	10 SEC

**AUDIO OUT**

Select the channel to output the audio signal. Please make sure the audio output device (such as a speaker) is connected to DVR

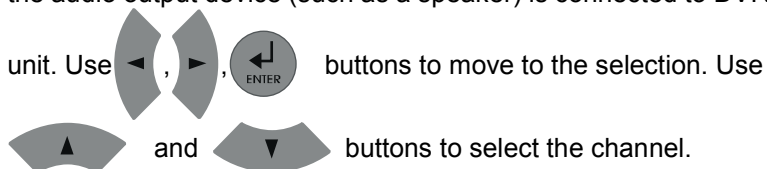

MAIN MENU	
	CAMERA
	<b>RECORD</b>
	HARD DRIVE
	SENSOR / ALARM
	MOTION
	NETWORK
	BACKUP
	SYSTEM

**RECORD**

To setup the recording relate parameters.

RECORD SETUP	
<b>RECORD MODE</b>	D1
RECORD FRAMERATE	240
VIDEO QUALITY	GOOD
RECORD SCHEDULE	

**RECORD MODE**

Select D1/CIF recording mode.

Under D1 mode, the video recording is in full screen resolution and takes turns from one channel to the next one when Auto Scan enables. Each channel is recorded only at a maximum frame rate of 15fps. User can switch to view the video in full screen or QUAD screen.

Whereas in CIF mode, video recording is at a lower resolution, but each video is recorded in 30fps/25fps (NTSC/PAL). User can switch to view the video in full screen or QUAD screen.

**RECORD FRAMERATE**

Set the number of frames per second to be recorded. Refer to the table below for the available record frame rate settings. The higher the frame rate is, it uses more hard disk space

Video Standard \ Record Mode	NTSC	PAL
D1	16, 80, 240	16, 80, 200
CIF	16, 80, 160, 240, 480	16, 80, 200, 400

**VIDEO QUALITY :**

Select the video quality setting from BEST, HIGH, MEDIUM, GOOD, NORMAL or LOW.





- **BEST** – best record quality but less record hours
- **LOW** – longest record hour but quality is ordinary
- **NORMAL** – allows you to record more hours but the quality of the recorded video is moderate

**OSD MENU**

**Description**

<b>RECORD SETUP</b>	
RECORD MODE	D1
RECORD FRAMERATE	240
VIDEO QUALITY	GOOD
<b>RECORD SCHEDULE</b>	

**RECORD SCHEDULE**

Use , , and  buttons to move to left and right. Use  and  buttons to select the mode of record schedule.

<b>RECORD SCHEDULE SETUP</b>	
	0 2 4 6 8 10 12 14 16 18 20 22 24
<b>SUN</b>	
<b>MON</b>	
<b>TUE</b>	
<b>WED</b>	
<b>THU</b>	
<b>FRI</b>	
<b>SAT</b>	
	<input type="checkbox"/> : ALWAYS RECORDING <input type="checkbox"/> : SENSOR RECORDING <input type="checkbox"/> : MOTION RECORDING <input type="checkbox"/> : NO RECORD

By default, in 24 hours, the recording schedule is set to always record every hour. Refer to the table below to customize the recording condition

Condition	Description
NO REC	Disable video recording
ALWAYS REC	Record non-stop
MOTION REC	Start recording when any movement is detected
SENSOR REC	Start recording when the sensor has triggered

<b>MAIN MENU</b>	
	CAMERA
	RECORD
	<b>HARD DRIVE</b>
	SENSOR / ALARM
	MOTION
	NETWORK
	BACKUP
	SYSTEM

**HARD DRIVE SETUP**

<b>HARD DRIVE SETUP</b>	
<b>OVERWRITE ENABLED</b>	YES
HDD1 SIZE	953,669 MB
HDD1 USED	1,936 MB
HDD1 FORMAT	
HDD2 SIZE	0 MB
HDD2 USED	0 MB
HDD2 FORMAT	

- **HDD 1/2 SIZE** shows the total capacity of the hard disk.
- **HDD 1/2 USED** shows the amount of space that has been used.

**OVERWRITE ENABLED**

Enable/disable overwriting the earliest record when the hard disk space runs out. By default, the HDD overwrite setting is enabled

HARD DRIVE SETUP		
OVERWRITE ENABLED	YES	
HDD1 SIZE	953,669 MB	
HDD1 USED	1,936 MB	
HDD1 FORMAT		
HDD2 SIZE	0 MB	
HDD2 USED	0 MB	
HDD2 FORMAT		

**HDD 1/2 FORMAT**

For security purpose, you may have to enter the password to format hard disk

To format hard disk:

1. Use  and  buttons to go up and down

and select **HDD 1/2 FORMAT**. Then press  or 

2. In the **ADMINISTRATOR PASSWORD** screen, press 

or . Then use  and  buttons to

select the security combination number. Repeat till you key in the last number (The default admin password is 111111).

ADMINISTRATOR PASSWORD	
CURRENT	*****
CHECK	

3. After entering the password, press .
4. And then, select **CHECK** and a confirmation screen will display. Press **YES(ENTER)** button to start formatting the hard disk. To cancel the hard disk formatting, press **NO(MENU)** button.

FORMAT HDD1 ?
YES (ENTER/ESC), NO (MENU/ESC)

5. It is done when the “**HDD FORMAT COMPLETED**” appears



Formatting the hard disk will permanently delete all the records and can no longer be retrieved

**OSD MENU**

**Description**

<b>MAIN MENU</b>	
	CAMERA
	RECORD
	HARD DRIVE
	<b>SENSOR / ALARM</b>
	MOTION
	NETWORK
	BACKUP
	SYSTEM

**SENSOR / ALARM**

To setup sensor and alarm relate parameters.

<b>SENSOR / ALARM SETUP</b>	
<b>SENSOR</b>	
ALARM	
SENSOR RECORD TIME	10 SEC
ALARM OUT TIME	010 SEC
SPOT MONITOR	

**SENSOR RECORD TIME**

Set the amount of time (in second) to start record when the sensor has triggered

**ALARM OUT TIME**

Set the amount of time (in second) to continue sending the alarm once triggered

<b>SENSOR SETUP</b>		
<b>CHANNEL - 1</b>	NOT	INSTALLED
CHANNEL - 2	NOT	INSTALLED
CHANNEL - 3	NOT	INSTALLED
CHANNEL - 4	NOT	INSTALLED
CHANNEL - 5	NOT	INSTALLED
CHANNEL - 6	NOT	INSTALLED
CHANNEL - 7	NOT	INSTALLED
CHANNEL - 8	NOT	INSTALLED
CHANNEL - 9	NOT	INSTALLED
CHANNEL - 10	NOT	INSTALLED
CHANNEL - 11	NOT	INSTALLED
CHANNEL - 12	NOT	INSTALLED
CHANNEL - 13	NOT	INSTALLED
CHANNEL - 14	NOT	INSTALLED
CHANNEL - 15	NOT	INSTALLED
CHANNEL - 16	NOT	INSTALLED

**SENSOR SETUP**

**CHANNEL 1~16 :**

Customize the initial state of the attached sensor. Refer to the table below to customize the sensor state

Condition	Description
NOT INSTALLED	Indicates that there is no sensor connected
NORMAL OPEN	Indicates that the initial state of the sensor is normal open. Video recording initiates when there is a changes in the sensor state
NORMAL CLOSE	Indicates that the initial state of the sensor is normal close. Video recording initiates when there is a changes in the sensor state

<b>SENSOR / ALARM SETUP</b>	
<b>SENSOR</b>	
<b>ALARM</b>	
SENSOR RECORD TIME	10 SEC
ALARM OUT TIME	010 SEC
SPOT MONITOR	

**ALARM SETUP**

<b>ALARM SETUP</b>	
<b>ALARM OUT</b>	
SENSOR	<input checked="" type="checkbox"/> 1 <input checked="" type="checkbox"/> 2 <input checked="" type="checkbox"/> 3 <input checked="" type="checkbox"/> 4 <input checked="" type="checkbox"/> 5 <input checked="" type="checkbox"/> 6 <input checked="" type="checkbox"/> 7 <input checked="" type="checkbox"/> 8 <input checked="" type="checkbox"/> 9 <input checked="" type="checkbox"/> 10 <input checked="" type="checkbox"/> 11 <input checked="" type="checkbox"/> 12 <input checked="" type="checkbox"/> 13 <input checked="" type="checkbox"/> 14 <input checked="" type="checkbox"/> 15 <input checked="" type="checkbox"/> 16
MOTION	<input checked="" type="checkbox"/> 1 <input checked="" type="checkbox"/> 2 <input checked="" type="checkbox"/> 3 <input checked="" type="checkbox"/> 4 <input checked="" type="checkbox"/> 5 <input checked="" type="checkbox"/> 6 <input checked="" type="checkbox"/> 7 <input checked="" type="checkbox"/> 8 <input checked="" type="checkbox"/> 9 <input checked="" type="checkbox"/> 10 <input checked="" type="checkbox"/> 11 <input checked="" type="checkbox"/> 12 <input checked="" type="checkbox"/> 13 <input checked="" type="checkbox"/> 14 <input checked="" type="checkbox"/> 15 <input checked="" type="checkbox"/> 16
VIDEO LOSS	<input checked="" type="checkbox"/> 1 <input checked="" type="checkbox"/> 2 <input checked="" type="checkbox"/> 3 <input checked="" type="checkbox"/> 4 <input checked="" type="checkbox"/> 5 <input checked="" type="checkbox"/> 6 <input checked="" type="checkbox"/> 7 <input checked="" type="checkbox"/> 8 <input checked="" type="checkbox"/> 9 <input checked="" type="checkbox"/> 10 <input checked="" type="checkbox"/> 11 <input checked="" type="checkbox"/> 12 <input checked="" type="checkbox"/> 13 <input checked="" type="checkbox"/> 14 <input checked="" type="checkbox"/> 15 <input checked="" type="checkbox"/> 16
HDD FAIL	ON
COPY SETTING VALUE TO BUZZER	

**ALARM OUT:**

Select the way of alarming – **BUZZER, RELAY-1, RELAY-2, RELAY-3, RELAY-4, or ALL.**

**SENSOR:**

Select the channel that will be send out the alarm when sensor has been triggered

**OSD MENU****Description**

ALARM SETUP	
<b>ALARM OUT</b>	<b>BUZZER</b>
SENSOR	<input checked="" type="checkbox"/> 1 <input checked="" type="checkbox"/> 2 <input checked="" type="checkbox"/> 3 <input checked="" type="checkbox"/> 4 <input checked="" type="checkbox"/> 5 <input checked="" type="checkbox"/> 6 <input checked="" type="checkbox"/> 7 <input checked="" type="checkbox"/> 8 <input checked="" type="checkbox"/> 9 <input checked="" type="checkbox"/> 10 <input checked="" type="checkbox"/> 11 <input checked="" type="checkbox"/> 12 <input checked="" type="checkbox"/> 13 <input checked="" type="checkbox"/> 14 <input checked="" type="checkbox"/> 15 <input checked="" type="checkbox"/> 16
MOTION	<input checked="" type="checkbox"/> 1 <input checked="" type="checkbox"/> 2 <input checked="" type="checkbox"/> 3 <input checked="" type="checkbox"/> 4 <input checked="" type="checkbox"/> 5 <input checked="" type="checkbox"/> 6 <input checked="" type="checkbox"/> 7 <input checked="" type="checkbox"/> 8 <input checked="" type="checkbox"/> 9 <input checked="" type="checkbox"/> 10 <input checked="" type="checkbox"/> 11 <input checked="" type="checkbox"/> 12 <input checked="" type="checkbox"/> 13 <input checked="" type="checkbox"/> 14 <input checked="" type="checkbox"/> 15 <input checked="" type="checkbox"/> 16
VIDEO LOSS	<input checked="" type="checkbox"/> 1 <input checked="" type="checkbox"/> 2 <input checked="" type="checkbox"/> 3 <input checked="" type="checkbox"/> 4 <input checked="" type="checkbox"/> 5 <input checked="" type="checkbox"/> 6 <input checked="" type="checkbox"/> 7 <input checked="" type="checkbox"/> 8 <input checked="" type="checkbox"/> 9 <input checked="" type="checkbox"/> 10 <input checked="" type="checkbox"/> 11 <input checked="" type="checkbox"/> 12 <input checked="" type="checkbox"/> 13 <input checked="" type="checkbox"/> 14 <input checked="" type="checkbox"/> 15 <input checked="" type="checkbox"/> 16
HDD FAIL	ON
COPY SETTING VALUE TO BUZZER	

**MOTION:**

Select the channel that will send out the alarm when motion has been detected

**VIDEO LOSS:**

Select the channel that will send out the alarm when video is lost.

**HDD FAIL:**

Enable/disable send out alarm when hard disk is failed.

**COPY SETTING VLAUE TO BUZZER:**

Copying alarm out setting to selected device.

SENSOR / ALARM SETUP	
SENSOR	
ALARM	
SENSOR RECORD TIME	10 SEC
ALARM OUT TIME	010 SEC
<b>SPOT MONITOR</b>	

**SPOT MONITOR**

Enable/disable to display channel alarm event in full screen mode when the sensor is activated or motion is detected. When there are multiple alarm events, DVR system will display the last alarm event.

SPOT MONITOR SETUP	
<b>SENSOR</b>	<input checked="" type="checkbox"/> 1 <input checked="" type="checkbox"/> 2 <input checked="" type="checkbox"/> 3 <input checked="" type="checkbox"/> 4 <input checked="" type="checkbox"/> 5 <input checked="" type="checkbox"/> 6 <input checked="" type="checkbox"/> 7 <input checked="" type="checkbox"/> 8 <input checked="" type="checkbox"/> 9 <input checked="" type="checkbox"/> 10 <input checked="" type="checkbox"/> 11 <input checked="" type="checkbox"/> 12 <input checked="" type="checkbox"/> 13 <input checked="" type="checkbox"/> 14 <input checked="" type="checkbox"/> 15 <input checked="" type="checkbox"/> 16
MOTION	<input checked="" type="checkbox"/> 1 <input checked="" type="checkbox"/> 2 <input checked="" type="checkbox"/> 3 <input checked="" type="checkbox"/> 4 <input checked="" type="checkbox"/> 5 <input checked="" type="checkbox"/> 6 <input checked="" type="checkbox"/> 7 <input checked="" type="checkbox"/> 8 <input checked="" type="checkbox"/> 9 <input checked="" type="checkbox"/> 10 <input checked="" type="checkbox"/> 11 <input checked="" type="checkbox"/> 12 <input checked="" type="checkbox"/> 13 <input checked="" type="checkbox"/> 14 <input checked="" type="checkbox"/> 15 <input checked="" type="checkbox"/> 16
CAMERA	1
SPOT MONITOR TIME	10 SEC

**SENSOR:**

Select the channel that will sent out the alarm event for display when the sensor has been triggered.

**MOTION:**

Select the channel that will send out the alarm event for display when the motion has been detected.

**CAMERA:**

Select the channel to display alarm event.

**SPOT MONITOR TIME:**

Set a period time (0 ~ 255 sec) for alarm event to display on surveillance screen.

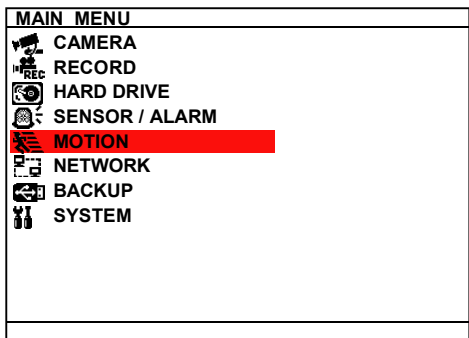

**MOTION SETUP**

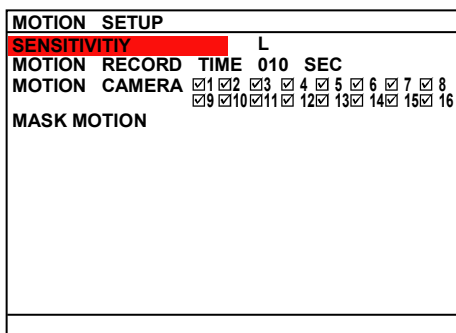

**SENSITIVITY:**

Set the sensitivity level. The sensitivity is from HI (High), 9~ 2 and LO (Low).

**MOTION RECORD TIME:**





Set the amount of time (in second) to record when motion is detected.

**MOTION CAMERA:**

Enable/disable the channel number to detect motion.

**MASK MOTION**

Select a specific area for motion recording. The DVR system will start recording when the selected area has been detected

motion. Use , ,  and  buttons to move to the left, right, up, and down. Use  buttons to select the area.

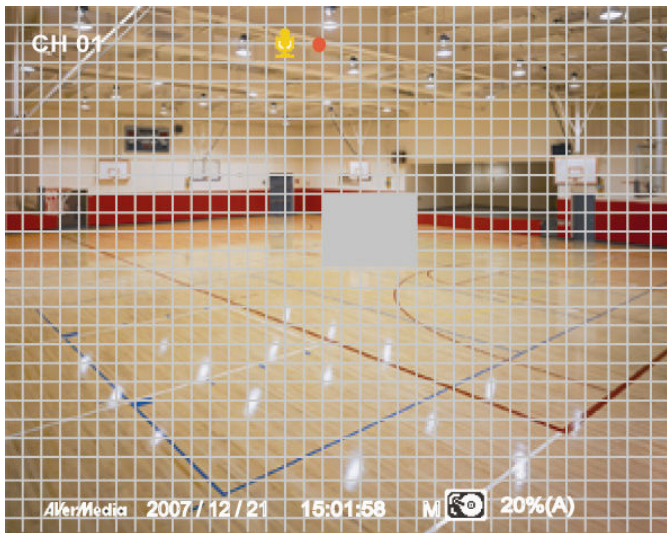

MAIN MENU	
	CAMERA
	RECORD
	HARD DRIVE
	SENSOR / ALARM
	MOTION
	<b>NETWORK</b>
	BACKUP
	SYSTEM

**NETWORK SETUP**

Setup the network parameters for the internet or intranet remote monitor or playback.

NETWORK SETUP	
<b>IP MODE</b>	
NW ENABLE	<input checked="" type="checkbox"/> 1 <input checked="" type="checkbox"/> 2 <input checked="" type="checkbox"/> 3 <input checked="" type="checkbox"/> 4 <input checked="" type="checkbox"/> 5 <input checked="" type="checkbox"/> 6 <input checked="" type="checkbox"/> 7 <input checked="" type="checkbox"/> 8 <input checked="" type="checkbox"/> 9 <input checked="" type="checkbox"/> 10 <input checked="" type="checkbox"/> 11 <input checked="" type="checkbox"/> 12 <input checked="" type="checkbox"/> 13 <input checked="" type="checkbox"/> 14 <input checked="" type="checkbox"/> 15 <input checked="" type="checkbox"/> 16
VIDEO PORT	0080
UPGARDE PORT	5005

**IP MODE**

The system provides 3 types of IP setup mode – STATIC, DHCP, and PPPOE.

IP MODE	
<b>IP MODE</b>	STATIC
IP ADDRESS	192 . 168 . 153 . 100
SUB NET	255 . 255 . 255 . 255
GATEWAY	192 . 168 . 153 . 254
DNS	000 . 000 . 000 . 000
MAC ADDRESS	00 . 18 . 1A . 02 . 00 . 0F
CHANGE	

Use and buttons to go up and down and select **IP MODE**, and then press . Use and buttons to change the selections and press or to make a selection.

- **STATIC:** Assigns a constant IP address for the DVR system.

Use and buttons to go up and down and select items, and then press or to make selection. Use and to move left and right to select or enter the configuration value.

- **IP ADDRESS:** Assign a constant IP address which a real IP addresses give from ISP to DVR system.

Do Not assign the DVR to 1.0.0.0 network segment. It will cause the DVR can not access to Internet due to the un-recognize to 1.0.0.0 IP segment.

- **SUBNET:** It is a bitmask used to identify the sub network and how many bits provide room for host addresses. Enter the subnet mask of the IP address which user has assigned to DVR system.
- **GATEWAY:** A network device act as a passageway to internet. Enter the network gateway IP address

**OSD MENU****Description**

IP MODE	
<b>IP MODE</b>	DHCP
IP ADDRESS	192 . 168 . 153 . 100
SUB NET	255 . 255 . 255 . 255
GATEWAY	192 . 168 . 153 . 254
DNS	000 . 000 . 000 . 000
MAC ADDRESS	00 . 18 . 1A . 02 . 00 . 0F
GET IP	

- **MAC ADDRESS:** Only for user information. Don't need to enter the MAC address.
- When all parameters are set, select the **CHANGE** to confirm the configuration.

- **DHCP:** Assign the IP address by local DHCP server to DVR system.



The DHCP (Dynamic Host Configuration Protocol) is a set of rules used by a communications device (such as a computer, router or networking adaptor) to allow the device to request and get an Internet address from a server which has a list of addresses available for assignment

Select **GET IP** to start getting IP. The DVR system will try to get an IP address from the DHCP server. A message window will show up as below:

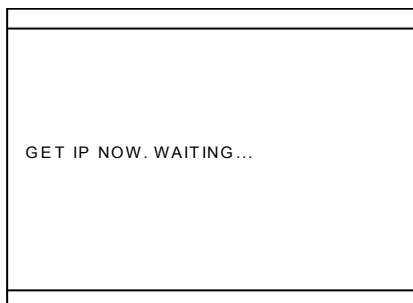

If system didn't get any network information, it means that get IP from DHCP server fail.

- **PPPOE:** Point-to-Point Protocol over Ethernet is a network protocol for encapsulating PPP frames in Ethernet frames. It is used mainly with ADSL services. If your network is using ADSL service connecting to internet, and then, select PPPOE mode, and then select **GET IP**. A message window will show up as below:

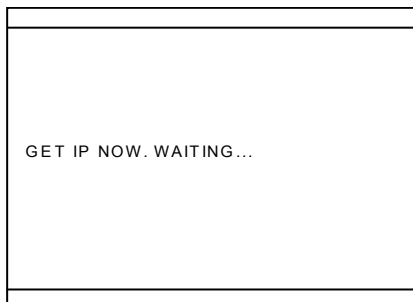

If system didn't get any network information, it means that get IP from PPPOE server fail.



Please go to [8.1.1.5 Network Setup # PPPOE](#) to setup PPPOE account and password for connecting to PPPOE server.

## OSD MENU

## Description

NETWORK SETUP	
<b>IP MODE</b>	
NW ENABLE	<input checked="" type="checkbox"/> 1 <input checked="" type="checkbox"/> 2 <input checked="" type="checkbox"/> 3 <input checked="" type="checkbox"/> 4 <input checked="" type="checkbox"/> 5 <input checked="" type="checkbox"/> 6 <input checked="" type="checkbox"/> 7 <input checked="" type="checkbox"/> 8 <input checked="" type="checkbox"/> 9 <input checked="" type="checkbox"/> 10 <input checked="" type="checkbox"/> 11 <input checked="" type="checkbox"/> 12 <input checked="" type="checkbox"/> 13 <input checked="" type="checkbox"/> 14 <input checked="" type="checkbox"/> 15 <input checked="" type="checkbox"/> 16
VIDEO PORT	0080
UPGARDE PORT	5005

### NW ENABLE:

Allow internet remote user to playback or monitor the channels. Without enabling the network function, the channels cannot be playback or monitor from remote site.

### VIDEO PORT:

A port for the remote connection. Any port can be assigned as a video port, except the ports already used by the network services. The default video port is 80.

### UPGRADE PORT:

A port for the remote update DVR system firmware. Any port can be assigned as an upgrade port, except the ports are already used by the network services. The default upgrade port is 5005.

**For Upgrading DVR firmware, please contact your local dealer.**



Please **DO NOT** cut off the power of the DVR system while the firmware is upgrading. Power failure will cause the permanent damage of the DVR system.

MAIN MENU	
	CAMERA
	RECORD
	HARD DRIVE
	SENSOR / ALARM
	MOTION
	NETWORK
	<b>BACKUP</b>
	SYSTEM

## BACKUP SETTING

Select the backup mode – USB or DVR+RW. A player application will be included in the backup folder. Before starting backup process, plug in the USB storage device or place the DVR+RW disk into DVD-ROM drive.

- **USB:** Using USB device (ex. Pen drive or External Hard disk) to backup partial recorded video and playback on PC.
- **DVD+RW:** backup partial recorded video on DVR+RW disk and playback on PC.

BACKUP SETTING	
BACKUP SELECT	USB

After select the backup mode, user need to select the backup period and hard disk.

BAKUP SETTING	
<b>HARD DISK</b>	HDD 1
START TIME	: 2008 / 01 / 04 10 : 00 : 01
END TIME	: 2001 / 01 / 05 13 : 08 : 13
CHANNEL	<input checked="" type="checkbox"/> 1 <input checked="" type="checkbox"/> 2 <input checked="" type="checkbox"/> 3 <input checked="" type="checkbox"/> 4 <input checked="" type="checkbox"/> 5 <input checked="" type="checkbox"/> 6 <input checked="" type="checkbox"/> 7 <input checked="" type="checkbox"/> 8 <input checked="" type="checkbox"/> 9 <input checked="" type="checkbox"/> 10 <input checked="" type="checkbox"/> 11 <input checked="" type="checkbox"/> 12 <input checked="" type="checkbox"/> 13 <input checked="" type="checkbox"/> 14 <input checked="" type="checkbox"/> 15 <input checked="" type="checkbox"/> 16
CALCULATE SIZE	89MB
BACKUP EXECUTE	

1. Select the **START TIME** and **END TIME**.
2. Select the channels which user wants to backup.
3. Select the **CALCULATE SIZE** to calculate the size of selected backup file.

## OSD MENU

## Description

BAKUP SETTING	
<b>HARD DISK</b>	HDD 1
START TIME	: 2008 / 01 / 04 10 : 00 : 01
END TIME	: 2001 / 01 / 05 13 : 08 : 13
CHANNEL	<input checked="" type="checkbox"/> 1 <input checked="" type="checkbox"/> 2 <input checked="" type="checkbox"/> 3 <input checked="" type="checkbox"/> 4 <input checked="" type="checkbox"/> 5 <input checked="" type="checkbox"/> 6 <input checked="" type="checkbox"/> 7 <input checked="" type="checkbox"/> 8 <input checked="" type="checkbox"/> 9 <input checked="" type="checkbox"/> 10 <input checked="" type="checkbox"/> 11 <input checked="" type="checkbox"/> 12 <input checked="" type="checkbox"/> 13 <input checked="" type="checkbox"/> 14 <input checked="" type="checkbox"/> 15 <input checked="" type="checkbox"/> 16
CALCULATE SIZE	89MB
BACKUP EXECUTE	

4. And then, select **BACKUP EXECUTE** and press **YES (ENTER)** to start backup video

BACKUP IN PROCESS	
	15%
AVAILABLE SIZE	820M

5. When backup is done, press any key to back to main menu.

USB BACKUP SUCCESSFUL
PRESS ANY KEY TO EXIT



- Remember to plug in the USB device or insert the DVR+RW disk into DVR-ROM drive before starting to backup.
- The DVR system doesn't supply the power to external device. Therefore, the external device must be power supplied by external power.

MAIN MENU	
	CAMERA
	RECORD
	HARD DRIVE
	SENSOR / ALARM
	MOTION
	NETWORK
	BACKUP
	<b>SYSTEM</b>

## SYSTEM

SYSTEM SETUP	
<b>MULTI-QUAD:LIVE</b>	
MULTI-QUAD:PLAY	
PASSWORD CHANGE	
CONFIGURATION	
TIME SETUP	
AUTO RECORD	OFF
AUDIO MUTE	OFF
MULTIPLE DVR	OFF
DVR ID	1
VGA RESOLUTION	1024x768
TEMPERATURE	
VIDEO SYSTEM	NTSC
OSD TRANSPARENCY	LEVEL - 2
LANGUAGE	ENGLISH
AA . 01 . 01 . 00 . 06	

## AUTO RECORD

Enable/disable auto continue recording when interrupted (i.e., power breakdown, video playback or configuration setup). It continue recording after 10 second of idleness. This is applicable in Always Record mode.

## MULTIPLE DVR

Enable/disable multiple DVR system remote control. When user has more than one DVR system, user can use **MULTIPLE DVR** function to control all DVR system by single remote control.

## OSD MENU

## Description

SYSTEM SETUP	
<b>MULTI-QUAD:LIVE</b>	
MULTI-QUAD:PLAY	
PASSWORD CHANGE	
CONFIGURATION	
TIME SETUP	
AUTO RECORD	OFF
AUDIO MUTE	OFF
MULTIPLE DVR	OFF
DVR ID	1
VGA RESOLUTION	1024x768
TEMPERATURE	
VIDEO SYSTEM	NTSC
OSD TRANSPARENCY	LEVEL - 2
LANGUAGE	ENGLISH
AA . 01 . 01 . 00 . 06	

### DVR ID

Assign the ID number for multiple DVR system remote controls. When there are more than one DVR systems, user can enable **MULTIPLE DVR** function, and then assign DVR ID to each DVR system. Then, user can just use one remote control to control all DVR system by pressing DVR ID. To remote control multiple DVR systems, press **FN** and number key (DVR ID number) on the remote control.

### VIDEO SYSTEM

DVR system will auto detect the video system and display

### OSD TRANSPARENCY

Adjust dark or light of OSD display windows.

### LANGUAGE

Select from the available languages

MULTI-QUAD:LIVE	
<b>SAVE TO HOT-KEY</b>	FN+5
MODE:	
QUAD1	1
QUAD2	3
QUAD3	4
QUAD4	6
QUAD5	8
QUAD6	10









### MULTI-QUAD:LIVE

DVR supports different kind of screen display modes in preview. User can set each display mode to the number button as a Hot-Key for switching.

### SAVE TO HOT-KEY:

Select a hot-key for the display mode. A hot-key is a combination of **FN** button and number button. The number button starts from 5 to 16 can be assigned as a hot-key number.

### MODE:

Select the display mode for just selected hot-key. Display mode has 8 kinds -- , , , , , , , and . Each mode can select channels (QUAD 1 ~ QUAD 16) for displaying.

MULTI-QUAD:PLAY	
<b>SAVE TO HOT-KEY</b>	FN+5
MODE:	
QUAD1	1
QUAD2	3
QUAD3	4
QUAD4	6
QUAD5	8
QUAD6	10







### MULTI-QUAD:PLAY

DVR supports different kind of screen display modes in playback. User can set each display mode to the number button as a Hot-Key for switching.

### SAVE TO HOT-KEY:

Select a hot-key for the display mode. A hot-key is a combination of **FN** button and number button. The number button starts from 5 to 16 can be assigned as a hot-key number.

### MODE:

Select the display mode for just selected hot-key. Display mode has 6 kinds -- , , , , , and . Each mode can select channels (QUAD 1 ~ QUAD 16) for displaying.

**OSD MENU****Description**

<b>PASSWORD SETUP</b>	
PASSWORD SETUP	NO
<b>ADMINISTRATOR</b>	
OPERATOR	
USER	

**PASSWORD CHANGE**

Enable/disable full system password protection. This would prevent unauthorized user to stop video recording, change system settings and formatting the hard disk.

**ADMINISTRATOR:**

Administrator has the authority of formatting hard disk, changing system settings, remote monitor the DVR system and changes the system settings. The factory default password is 111111.

<b>ADMINISTRATOR PASSWORD</b>	
<b>CURRENT</b>	*****
NEW	*****
CONFIRM	*****
EXECUTE	

**OPERATOR:**

The login account for remote connection through the internet. User account only can view and playback recorded video by Web viewer (ex: Internet Explorer), but no authority to change the DVR system's setting. The factory default password is 111111.

<b>OPERATOR PASSWORD</b>	
<b>CURRENT</b>	*****
NEW	*****
CONFIRM	*****
EXECUTE	

**USER:**

The login account for general user. No superuser authority but can preview live video. The factory default password is 111111.

<b>USER PASSWORD</b>	
<b>CURRENT</b>	*****
NEW	*****
CONFIRM	*****
EXECUTE	

**OSD MENU****Description**

<b>SYSTEM SETUP</b>	
MULTI-QUAD:LIVE	
MULTI-QUAD:PLAY	
PASSWORD CHANGE	
<b>CONFIGURATION</b>	
TIME SETUP	
AUTO RECORD	OFF
AUDIO MUTE	OFF
MUTLIPLE DVR	OFF
DVR ID	1
VGA RESOLUTION	1024x768
TEMPERATURE	
VIDEO SYSTEM	NTSC
OSD TRANSPARENCY	LEVEL - 2
LANGUAGE	ENGLISH
AA . 01 . 01 . 00 . 06	

**CONFIGURATION**

Backup and resort the DVR system setting.

<b>CONFIGURATION SETUP</b>	
<b>SAVE CONFIGURATION</b>	
RESTORE CONFIGURATION	

**SAVE CONFIGURATION:**

Backup the current DVR system setting to USB device. Plug in the USB storage device before starting to save the configuration.

<b>CONFIGURATION SETUP</b>	
<b>SAVE CONFIGURATION</b>	
RESTORE CONFIGURATION	
CONFIGURATION SAVE OK	

**RESTORE CONFIGURATION:**

To restore the previous saved DVR system setting.

RESTOR FINISHED. SHUT DOWN DVR	
--------------------------------	--

**OSD MENU****Description**

<b>TIME SETUP</b>		
<b>DATE FORMAT</b>	YYYY/MM/DD	
DATE	2008 / 03 / 12	WED
TIME	21 : 07 : 45	
AUTO SYNC TIME	OFF	
TIME ZONE	GMT	
LAST SYNC TIME	2008 / 01 / 01	00 : 00 : 00
DAYLIGHT SAVING		

**TIME SETUP**

Setup system date, time, daylight saving, and enable auto synchronize time through network.

**DATE FORMAT:**

Select the display format of the date

**DATE :**

Set the current date

**TIME :**

Set the current time

**AUTO SYNC TIME:**

Enable/disable time synchronization automatically through network. The DVR system will auto synchronize time from NTP servers. The first time synchronize will be 6 hours later after system power up. When the daylight saving is enabling, the auto time synchronization will be stopped.



- User need to setup the NTP server's URL or IP address. Please go to [8.1.1.1 System Setting #\(3\) NTP Setting](#) to setup the NTP server.
- If the NTP server doesn't setup, the auto synchronize time function will not work correctly.

**TIME ZONE:**

Select the time synchronization time zone. The time zone will base on GMT (Greenwich Mean Time) time zone.

**LAST SYNC TIME:**

Display the latest time synchronization date and time.

<b>DAYLIGHT SAVING</b>		
<b>DAYLIGHT SAVING</b>	OFF	
START	: 2007 / 03 / 10	00 : 00
END	: 2007 / 10 / 09	00 : 00
TIME OFFSET	01 : 00	

**DAYLIGHT SAVING:**

To enable/disable daylight saving function.

**START:**

Setup daylight start up date and time.

**END:**

Setup daylight stop date and time.

**TIME OFFSET:**

Assign a time that it is for daylight saving time offset in your time zone. For example: if the time zone is in U.S. Eastern, the time offset is 1 hour.

**OSD MENU****Description**

TEMPERATURE SETUP	
TEMPERATURE FORMAT	°C
HIGH THRESHOLD	035
LOW THRESHOLD	030
DVR HOT PROTECT	055

**TEMPERATURE SETUP**

Set the DVR unit temperature type and high/low threshold limit.

**TEMPERATURE FORMAT:**

Temperature pattern display on front LED panel.

**HIGH THRESHOLD:**

Set a specific temperature limited (0 ~ 100°C) for fan active. When the hard disk temperature is higher than limited temperature, the fan will be active. The default value is 35°C.

**LOW THRESHOLD:**

Set a specific temperature limited (0 ~ 30°C) for fan stop. When the hard disk temperature is lower than limited temperature, the fan will be stop. The default value is 30°C.

**DVR HOT PROTECT:**

Set the temperature limit to shutdown hard disk when the DVR unit temperature is higher than (>) limited (55 ~ 70°C).

# Chapter 4 Using the USB Playback Console

## 4.1 Recommended system requirements

- Pentium®4 2.4GHZ or above
- Windows®2000/ XP
- DDR 256 MB
- Graphic function must support DirectDraw
- Audio card or built-in
- Speaker
- 1 available USB2.0 port

## 4.2 Installing the USB Playback Console

To install the USB Playback Console:

1. Place Installation CD into the CD-ROM drive. When the installation main screen appears, click **Install USB Playback Console** and then follow the on screen instructions



2. Select the language you prefer



3. Click **OK** to install the application
4. Click **Exit** to close the installation main screen. You may plug in the pen drive or external hard disk now.

## 4.3 Running the USB Playback Console

To run the application, click the  icon on the PC desktop

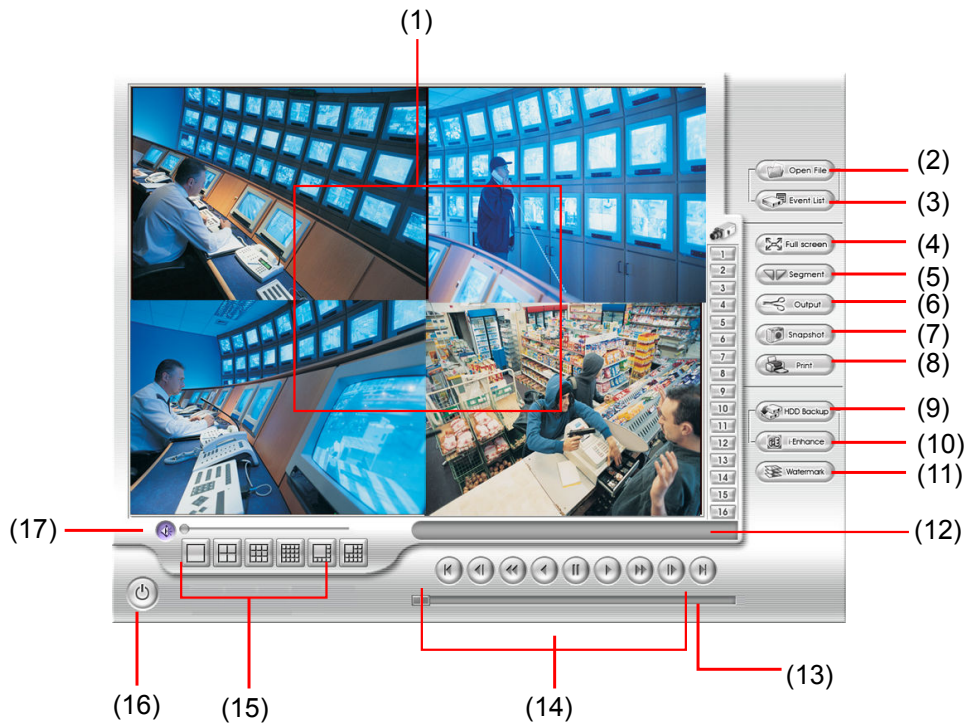

Name	Function
(1)	Video playback screen

To select the video file for playing. The playback application supports \*.dvr and \*.avf file.

(2) Open File



- **DVR Recorded File (HD):** To playback the recorded video from the hard disk which was recording video on the DVR system. (see also [4.3.2](#))
- **Backup File(.dvr):** The file is backup and save in \*.dvr file format. (see also [4.3.3](#))
- **Backup File(.avf):** The file is backup and save in \*.avf file format. The recorded video backup to pen drive is in \*.avf (see also [4.3.4](#))

Name	Function
------	----------

Select the event you want to playback. The event list only available when user select to playback in **DVR Recorded File(HD)**.

(3) Event List

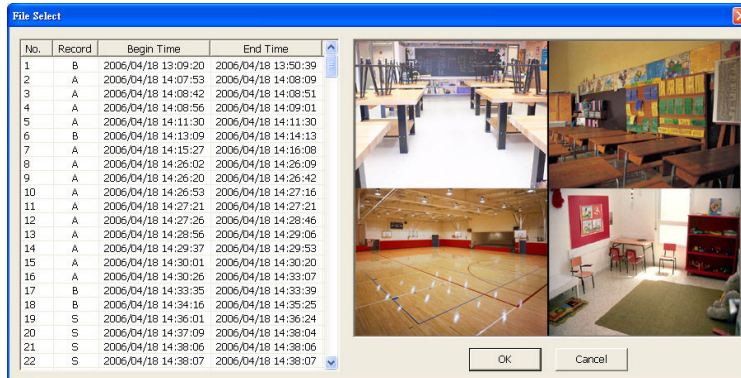

(4) Full screen

Use the entire area of the screen to only display the video. To return, press the right button of the mouse or **ESC** on the keyboard.  
When you switch to full screen in multiple-screen mode, Left click to toggle to only display one of the video in the multiple-screen mode or all.

(5) Segment

Keep a portion of the recorded video (see also [4.3.1](#))

(6) Output

Save the segmented file in \*.mpg or \*.avi format (see also [4.3.1](#)).

(7) Snapshot

Capture and save the image either in \*.jpg or \*.bmp format

(8) Print

Print the image

(9) HDD Backup

To call out HDD Backup application. (See [Chapter 5](#))

(10) iEnhance

To call out iEnhance application. ( See [Chapter 7](#))

(11) Watermark

To call out ImageVerification application. (See [Chapter 6](#))

(12) Status Bar

Display the recorded date, time and play speed.

(13) Progress Bar

Show the progress of the file being played. You may move the bar to seek at any location of the track.

(14) Playback Controller

**Begin:** Move at the beginning of the recorded video file.  
**Previous:** Go back to the previous frame by frame.  
**Slower:** Play the recorded video file at the speed of 1/2X, 1/4X, or 1/8X.  
**Rewind:** Wind back the recorded video file.  
**Pause:** Briefly stop playing the recorded video file.  
**Play:** Play the recorded video file.  
**Faster:** Play the recorded video file at the speed of 2x, 4x, 8x, or 16x.  
**Next:** Go to the next frame by frame.  
**End:** Go to the end of the recorded video file.

(15) Split Screen Mode

Select from different screen view to playback the recorded video file of the entire camera or one camera on screen.

(16) Exit

Exit/ Minimize the application or chose Cancel to go back to the application

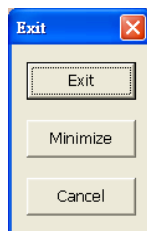

(17) Sound /Sound bar

Turn on and off the sound  
Increase and decrease the volume

### 4.3.1 To Cut and Save the Portion of the Recorded Video

1. Use the Playback Control buttons or drag the bar on the playback progress bar and pause on where you want to start the cut. Then, click **Segment** to set the begin mark.



2. Use the Playback Control buttons or drag the bar on the playback progress bar and pause on where you want to end the cut. Then, click **Segment** to set the end mark. To cancel segmentation, click **Segment** button again.



3. Click **Output** button to save the wanted portion.
4. In the **Save As** dialog box, locate on where user wants to save the file, type the filename, and select the video format.

### 4.3.2 Playback DVR Recorded File from Hard Disk

1. Please have the hard disk which containing of recorded video data install on your PC or using external USB enclosure to connect to your PC.
2. Click **Open File** button
3. Select **DVR Recorded File(HD)** and click **OK**.
4. Select the hard disk drive from **Select Disk** window and click **OK**.

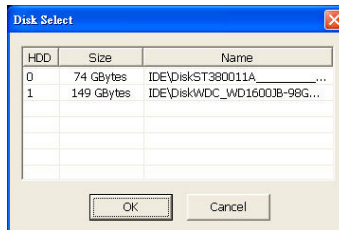

5. And then, the **File Select** window appears. Select the event that user wants to play and click **OK**. Click **Next** to go next page and click **Pre** to go back last page of event list. Also, enter the page number in **page column** and click go can direct go to the page.

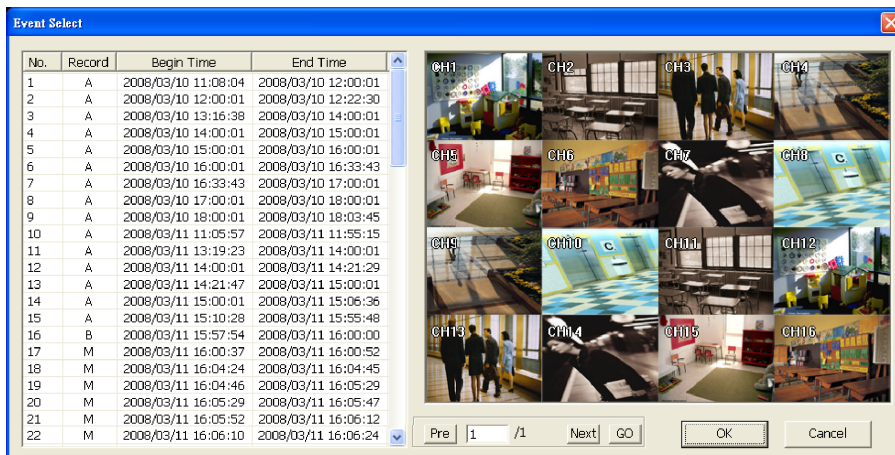

### 4.3.3 Playback Backup File(\*.dvr)

1. Click **Open File** button.
2. Select **Backup File(\*.dvr)** and click **OK**.
3. Locate the backup file folder and click **OK**.



When open the backup video file, just locate the where folder of backup file is.

4. And then, **Playback Date/Time Selection** window appears. Select the date and time and click **OK**.

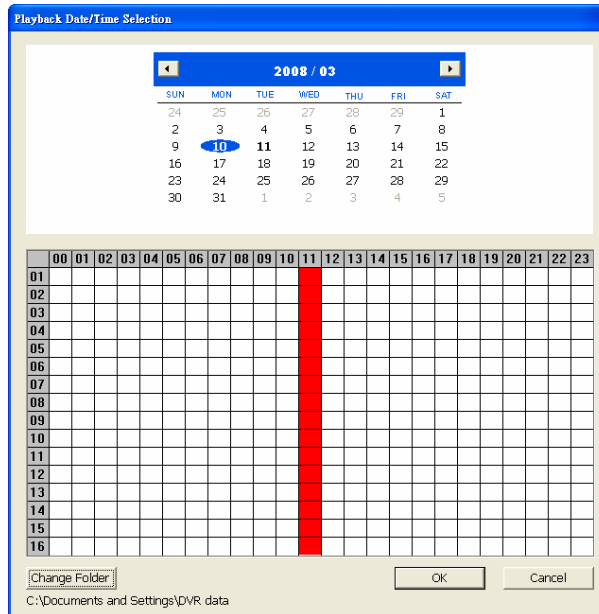

### 4.3.4 Playback Backup File (\*.avf)

To playback backup file in \*.avf format, user can use the AVFPlayback application that included in backup folder when backup into USB storage device. Also, user can use USB Playback Console to playback backup file (see also [4.3](#)).

1. Plug the USB storage device into PC USB port.
2. Run **AVFPlayback** from USB storage device
3. Click **Open** in AVFPlayback UI
4. Click **Select Folder** to locate the backup files

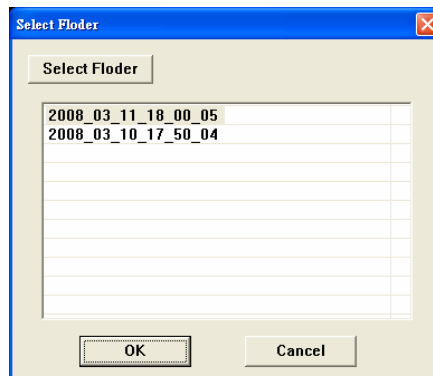

5. And then, select the backup file and click **OK**

# Chapter 5 Backup Recorded Video File

## 5.1 Recommended system requirements

- Pentium®4 2.4GHZ or above
- Windows®2000/ XP
- DDR 256 MB
- Graphic function must support DirectDraw
- Audio card or built-in
- Speaker
- 1 available USB2.0 port

## 5.2 Familiarizing with HDD Backup Application

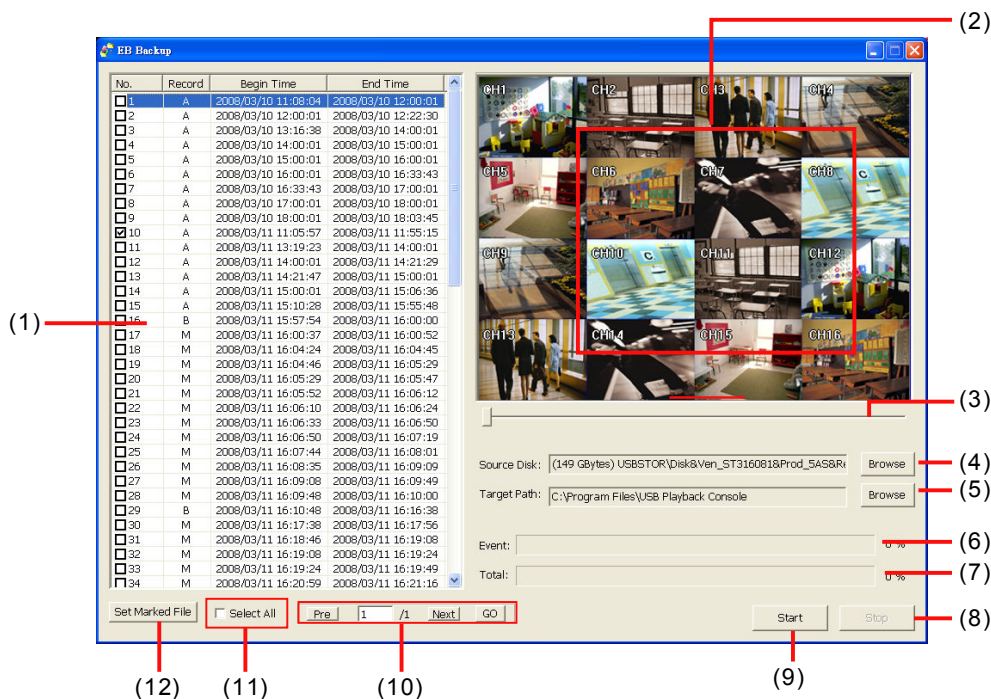

Name	Function
(1) All recorded video events list	<b>No.:</b> the list order number <b>Record:</b> the record type(see also <a href="#">Chapter 2.3.1</a> ) <b>Begin Time:</b> the beginning of record time <b>End Time:</b> the end of record time
(2) Video Display	Display first frame of each recorded channel video which user had selected.
(3) Progress bar	Show the progress of the event being played. User may move the bar to seek at any location of the track

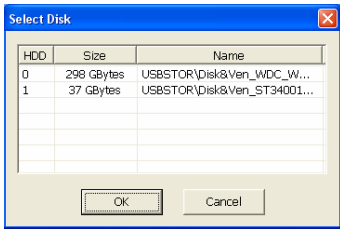
Name	Function
(4) Source Disk	To select the hard disk drive
	
(5) Target Path	To locate on where user want to save the file
(6) Event (%)	Display the backup progress rate of event in percentage
(7) Total (%)	Display the total backup progress rate in percentage
(8) Stop	Stop backup progress
(9) Start	Start backup progress
(10) Page Switch	<p><b>Pre:</b> go back last page</p> <p><b>Next:</b> go to next page</p> <p><b>Page column:</b> enter the page number and click <b>Go</b> button to go to the page</p>
(11) Select All	Select all listed recorded video events. Click the check box again to cancel for selecting all events.
(12) Set Marked File	Use <b>Ctrl</b> and mouse to select the multiple events from event list, and then click <b>Set Marked File</b> to mark multiple events. When click <b>Set Marked File</b> button, the marked event will turn to un-mark and un-mark event will turn to marked.

### 5.3 To Backup Recorded Video File

1. Please have the hard disk which was recording video on the DVR system install on your PC or using external USB enclosure to connect to your PC.
2. To run the HDD Backup application, click the **HDD Backup** button on USB Playback Application main interface.
3. Click **Browse** in **Source Disk** to locate the recorded video file.
4. And then, the **Select Disk** windows will appear as below:

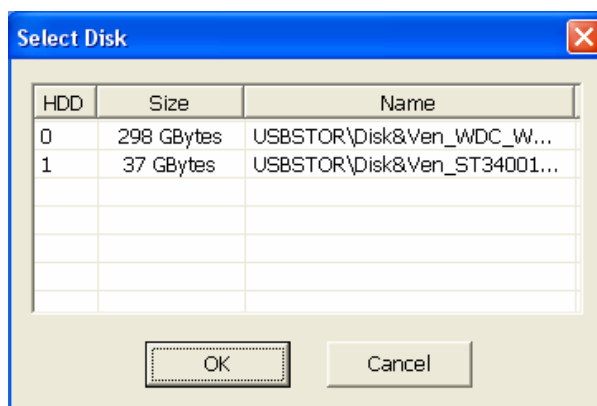

5. Select the hard disk drive from **Select Disk** windows. All available hard disk will list on the **Select Disk** windows with size and name

6. Select the hard disk drive and click **OK**
7. And then, all the recorded video files will list out.
8. Select the event which user wants to backup. Or mark the **Select All** to select all listed recorded video event
9. Locate on where user wants to save the backup file
10. Click **Start** to process backup
11. To stop the backup progress, click **Stop**
12. To play the backup file, see [4.3.3](#).

# Chapter 6 ImageVerification

Image Verification is a watermark-checking program to identify the authenticity of a saved image (e.g. by snapshot). This program can only verify uncompressed bmp image files.

## 6.1 To Run the ImageVerification

1. To run the ImageVerification application, click the **Watermark** button on USB Playback Console main interface.
2. In the ImageVerification screen, click **Load Source Image** and locate the image source.
3. Click **Verify Image** to begin the process.
4. Check the result in the **Processed Image** screen. If the picture is unmodified, the image in the **Source Image** and **Processed Image** screen would be exactly the same. If the picture is being modified, a warning dialog box would prompt and the modified area is highlighted.

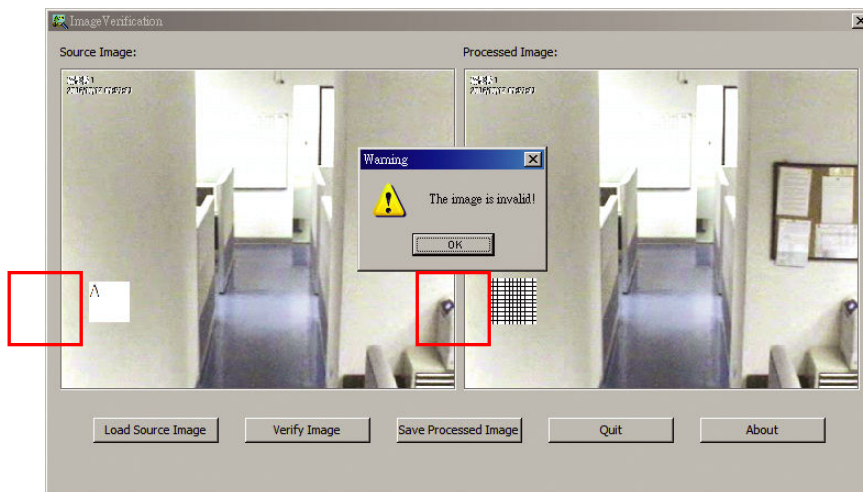

# Chapter 7 iEnhance

The bundled iEnhance is a video editing tool and can only be used with \*.dvr video file. It allows you to adjust the video picture quality, segment and save the selected portion of the video, zoom in and out the image, and print or save the screen shot. You can also save the setting and apply it on other files.

To run iEnhance application, click **iEnhance** button on USB Playback Console interface.

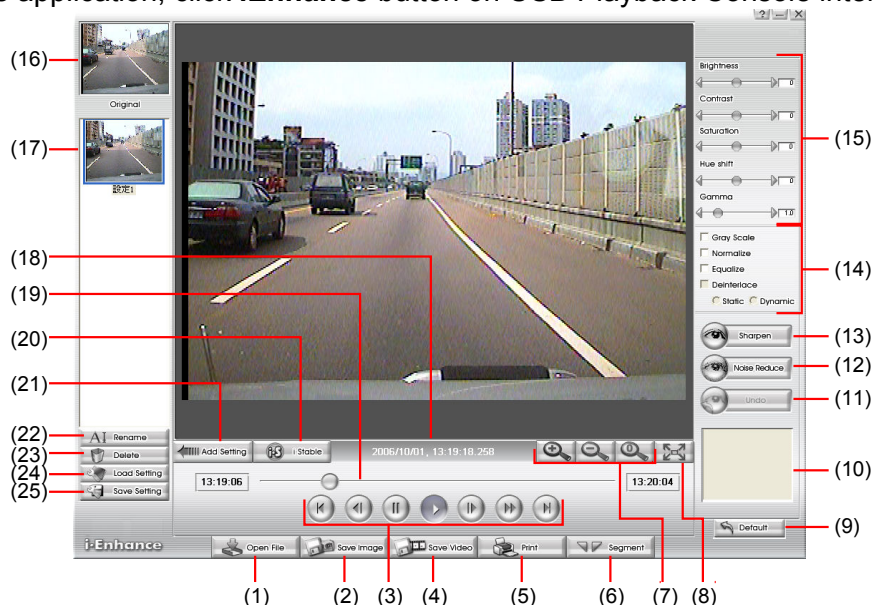

Name	Function
(1) Open File	Access *.dvr video file.
(2) Save Image	Capture and save the screen shot in *.bmp format.
(3) Playback Control Buttons	Begin: Move at the beginning of the video file. Previous: Go back to the previous frame. Rewind: Wind back the video file. Pause: Temporary stop playing the video file. Play: Play the video file. Faster: Play the video file at the speed of 2x, 4x, or 8x. Next: Go to the next frame. End: Go to the end of the video file.
(4) Save Video	Save the edited or segmented video in *.avi format.
(5) Print	Print the screen shot.
(6) Segment	Mark the beginning and the end of the selected portion of the video. Two triangle marks will appear on the slider. To cancel video segmentation, click this button again.
(7) Zoom Buttons	Enlarge, reduce, and set the image back to normal size.
(8) Full Screen	Use the entire screen to only display the video.
(9) Default	Set the video back to original state and delete all the changes in the history box.
(10) History Box	List all the actions.
(11) Undo	Delete the last action.

Name	Function
(12) Noise Reduce	Adjust the softness and repair the damaged colours.
(13) Sharpness	Improve the overall image by enhancing edges. This gives the image more depth.
(14) Effects	Gray Scale: convert the image into black and white (monochrome). Normalize: adjust the brightness intensity. Equalize: automatically adjust the images that are too dark. De-interlace: smooth out the overlying frames. Static: de-interlace for motionless scene. Dynamic: de-interlace for moving scene.
(15) Picture Adjustment	Adjust the Brightness, Contrast, Saturation, Hue and Gamma.
(16) Original Screen	Display the original state of the image.
(17) Temporary Setting Block	Display the sample settings. Click the sample to apply the setting on the current video.
(18) Status Bar	Display the date, and time of the video.
(19) Progress Bar	Show the progress of the file being played. You may move the bar to seek at any location of the track.
(20) iStable	To reduce the jolt in the recorded video.(also see <a href="#">Chapter 7.1</a> )
(21) Add Setting	Include the new setting to the temporary setting block.
(22) Rename	Change the name of the selected setting in the temporary setting block.
(23) Delete	Permanently remove the selected setting in the temporary setting block.
(24) Load Setting	Call the saved settings.
(25) Save Setting	Store the settings in the temporary setting block.

## 7.1 To Use iStable

The iStable function can reduce the jolt in the recorded video.

1. Click **Open File** button and select the recorded video.
2. And then, click **iStable** button.
3. iStable windows will show up.
4. Select the **smoothness** level – 1(Low), 2, 3, 4, and 5(High). The default value is 3.
5. Click Play button, and then iStable function will start to initial the recorded video.
6. When the initialize is done, user will see the original and stabilized recorded video play in two windows. The original video on the right side of window and the stabilized video on the left side of window.

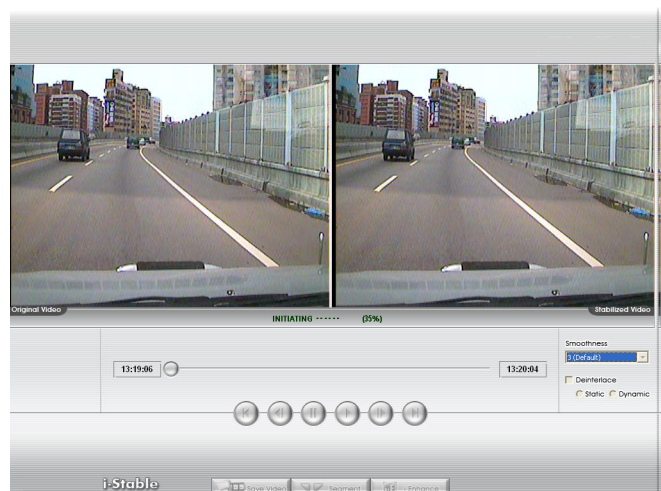

## Chapter 8 Using the Remote Programs

User can use Microsoft Internet Explorer to access DVR system by entering the IP address. To use this feature, make sure that you PC and EB5416DVD Pro both are connected to the internet and the Network feature is enabled.

Accessing this feature for the first time you will be prompted by your browser to install WebCamX.cab, allow the installation and you should be able to connect and login afterwards.

For Windows 2000, click **Yes** when the Security Warning dialog box appears.

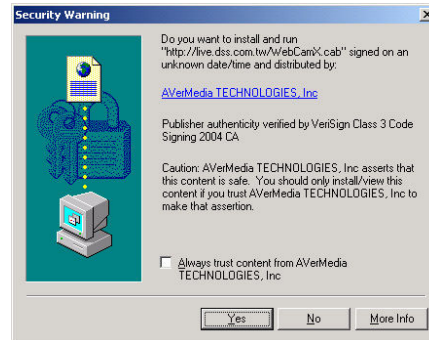

For Windows XP, click Install when the Internet Explorer - Security Warning dialog box appears.

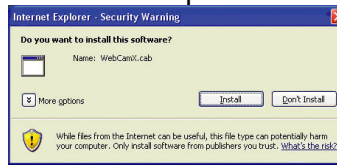

After installing the WebCamX.cab and when connecting to the DVR system, you are required to enter User ID (Superuser or User) and password (default password is 111111) and select the type of network. Superuser has the authority to remote setup the DVR system configuration on Web Viewer.



Changing the Superuser and User default password is strongly recommended.

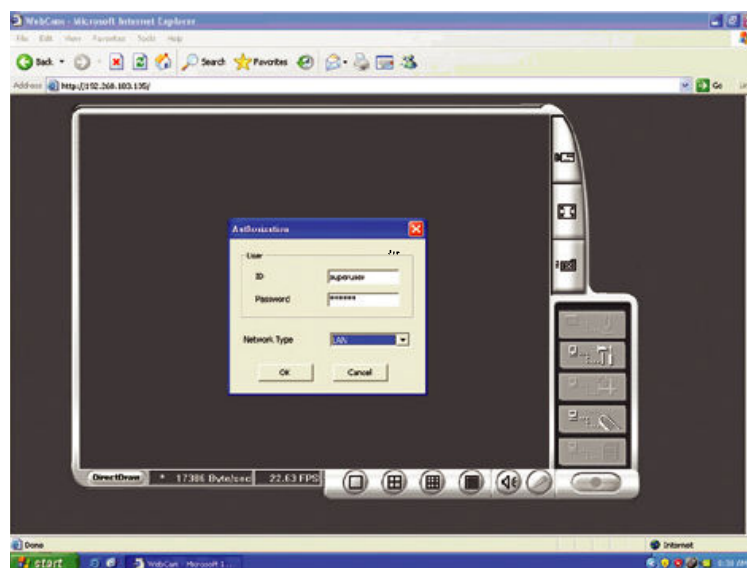

## 8.1 Familiarizing the Web Viewer Buttons

Right-clicking on the Web Viewer video screen, enables you to start video recording, change video quality, switch camera and enable/disable DirectDraw.

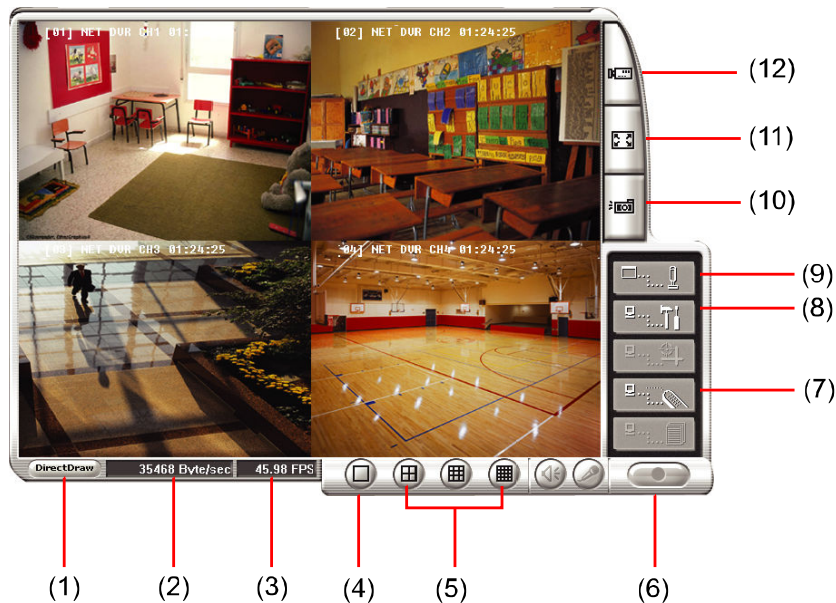

Name	Function
(1) DirectDraw	Enhance the video quality.
<p><b>i</b> Not all graphic cards can support this function. If you can not see the screen display correctly or screen is messed, please check with VGA card vendor.</p>	
(2) Received file size	Indicate the size of the data being sent per second.
(3) Camera frames	Indicate the number of frames per second.
(4) One screen view	To view single camera view on screen. User can right click on the screen to switch to different camera view.
(5) Split screen view	To view all cameras on screen simultaneously.
(6) Record	Start to record the video of the selected camera in AVI format. Directly click screen to select the channel that user wants to record and press <b>Record</b> button.
(7) Remote Console	Initiate Remote Console. It allows you to control DVR server (see also <a href="#">Chapter 8.2</a> ).
(8) Remote setup	Change the DVR server settings (see also <a href="#">Chapter 8.1.1</a> ).
<p><b>i</b> Only Superuser has the authority to remote setup DVR system.</p>	
(9) PTZ Control	Initiate PTZ camera controller(see also <a href="#">Chapter 8.3</a> )
(10) Snapshot	Capture and save the screen shot in *.bmp format.
(11) Full screen	Use the entire area of the screen to only display the video. To return, Right click the mouse or press ESC on the keyboard.

Name	Function
(12) Select cameras to view	<p>Select to the view camera from different server. In Select Camera dialog box, Display column, click to enable/disable viewing the camera.</p> <p>Click <b>Add Server</b> and select the server type between DVR and IP Cam to add.</p> <p>Click <b>Delete Server</b> to delete the selected item.</p> <p>Click Import to load the previous saved list.</p> <p>Click <b>Export</b> to save the list.</p> <p>Click <b>Apply All</b> to change all the camera video quality based on the selected setting.</p> <p>Click <b>OK</b> to exit.</p>

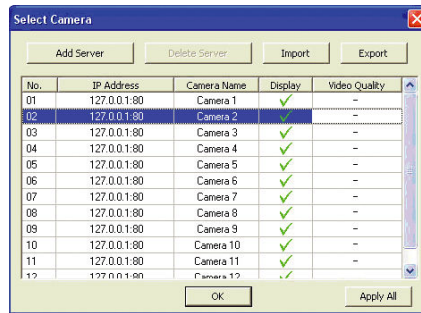

## 8.1.1 To Setup Remote System Setting

Click **OK** to exit and save the setting and **Cancel** to exit without saving the setting. The setting here applies to Remote DVR system only.

-  - After changed the DVR system setting, refresh your web browser in order to apply the new setting to the DVR system.
- Only the superuser has the authority to change remote DVR system settings.

### 8.1.1.1 System Setup

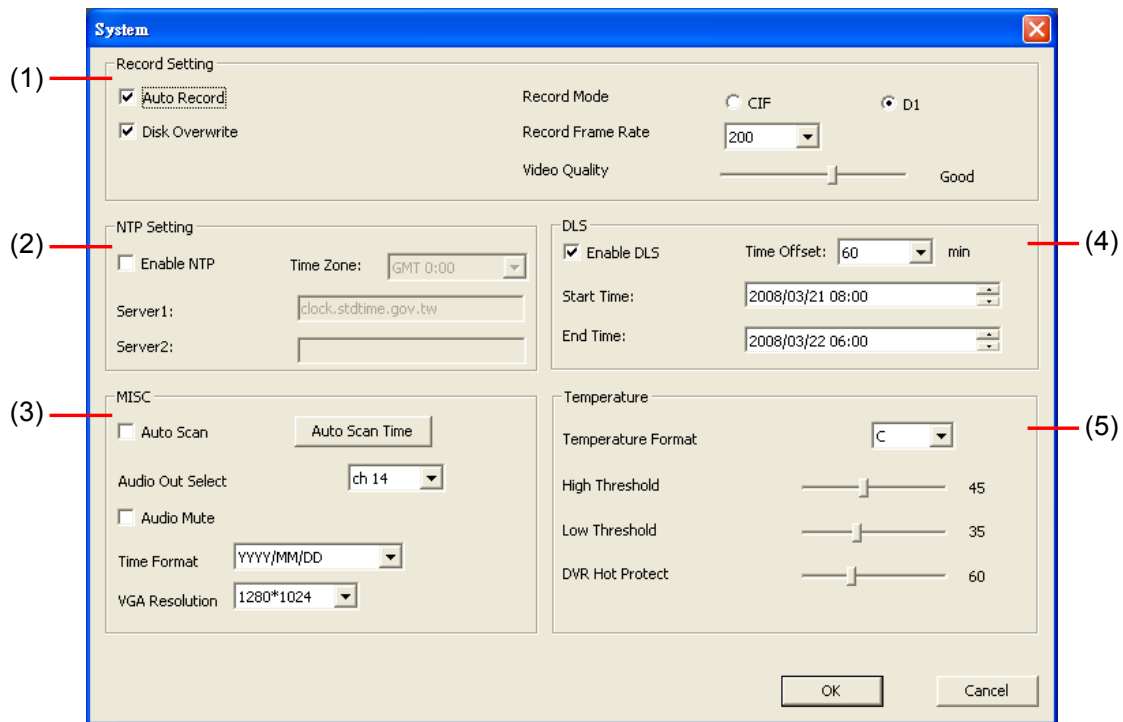

#### (1) Recording Setting

- **Auto Record**  
Enable/disable auto continue recording when interrupted (i.e., power breakdown, video playback or configuration setup). It continue recording after 10 second of idleness. This is applicable in Always Record mode.
- **Disk Overwrite**  
Enable/disable replacing the earliest record when the hard disk space runs out. By default, the HDD overwrite setting is enabled
- **RECORD MODE**  
Select D1/CIF recording mode. Under D1 mode, the video recording is in full screen resolution and takes turns from one channel to the next one when Auto Scan enables. Each channel is recorded only at a maximum frame rate of 15fps. User can switch to view the video in full screen or QUAD screen. Whereas in CIF mode, video recording is at a lower resolution, but each video is recorded in 30fps/25fps (NTSC/PAL). User can switch to view the video in full screen or QUAD screen
- **RECORD FRAMERATE**  
Select the number of frames per second to be recorded. Refer to the table below for the available record frame rate settings. The higher the frame rate is, it uses more hard disk space

Video Standard Record Mode	NTSC	PAL
D1	16, 80, 240	16, 80, 200
CIF	16, 80, 160, 240, 480	16, 80, 200, 400

- **VIDEO QUALITY**

Select the video quality setting from BEST, HIGH, MEDIUM, GOOD, NORMAL or LOW.

**BEST** – best record quality but less record hours

**LOW** – longest record hour but quality is ordinary

**NORMAL** – allows you to record more hours but the quality of the recorded video is moderate.

**(2) NTP Setting**

Setup the time auto synchronization.

- **Enable NTP**

Enable/disable time synchronization automatically through network. The DVR system will auto synchronize time from NTP servers which user has entered in following server 1 and server 2 column.



When the daylight saving is enabling, the auto time synchronization will be stopped.

- **TIME ZONE:**

Select the time synchronization time zone. The time zone will base on GMT (Greenwich Mean Time) time zone.

- **Server 1/Server 2**

Fill in the network time server URL or IP address (clock.stdtime.gov.tw or time.stdtime.gov.tw)

**(3) MISC**

- **Auto Scan**

Enable/disable auto cycle switch to display the next channel when in full screen preview. User can set different switch time for each channel. The time range is from 5 ~30 seconds. Click **Auto Scan Time** to set the auto scan time period.

- **Audio Out Select**

Select the channel to output the audio signal. Please make sure the audio output device (such as a speaker) is connected to DVR unit.

- **Audio Mute**

Enable/disable to hear audio sound of local DVR. To hear sound, make sure the unit is connected to an audio output device (ex: speaker). If user recorded video in audio mute status, there is no sound when playback

- **Time Format**

Select the display format of the date

- **VGA Resolution**

Select the display resolution

**(4) DLS**

Setup daylight saving settings.

- **Enable DLS**

To enable/disable daylight saving function.

- **START**  
Setup daylight start up date and time.
- **END**  
Setup daylight stop date and time.
- **TIME OFFSET**  
Assign a time that it is for daylight saving time offset in your time zone. For example: if the time zone is in U.S. Eastern, the time offset is 1 hour.

## (5) TEMPERATURE

Set the DVR unit temperature type and high/low threshold limit.

- **TEMPERATURE FORMAT:**  
Temperature pattern display on front LED panel.
- **HIGH THRESHOLD:**  
Set a specific temperature limited (0 ~ 100°C) for fan active. When the hard disk temperature is higher than limited temperature, the fan will be active. The default value is 35°C.
- **LOW THRESHOLD:**  
Set a specific temperature limited (0 ~ 30°C) for fan stop. When the hard disk temperature is lower than limited temperature, the fan will be stop. The default value is 30°C.
- **DVR HOT PROTECT:**  
Set the temperature limit to shutdown hard disk when the DVR unit temperature is higher than (>) limited (55 ~ 70°C).

### 8.1.1.2 Camera Setup

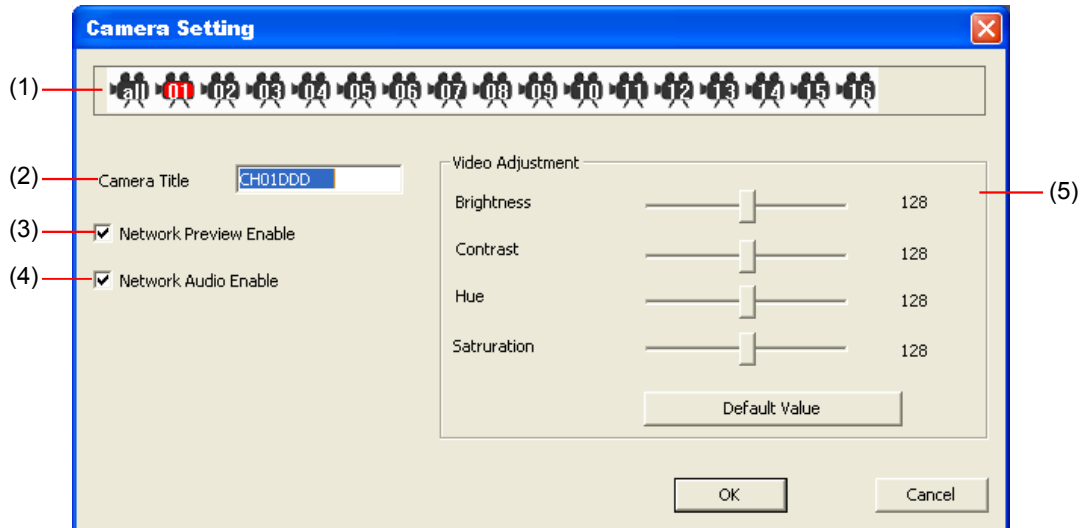

#### (1) Camera icon

Select the camera that user wants to set up.

#### (2) Camera Title

Enter a name for the camera

#### (3) Network Audio Enable

Enable/disable the audio sound record when recording the video through network.

#### (4) Video Adjustment

Select the camera and adjust the Brightness, Contrast, Hue and Saturation of the selected camera. Click **Default Value** to set all video setting back to the default.

### 8.1.1.3 Record Setup

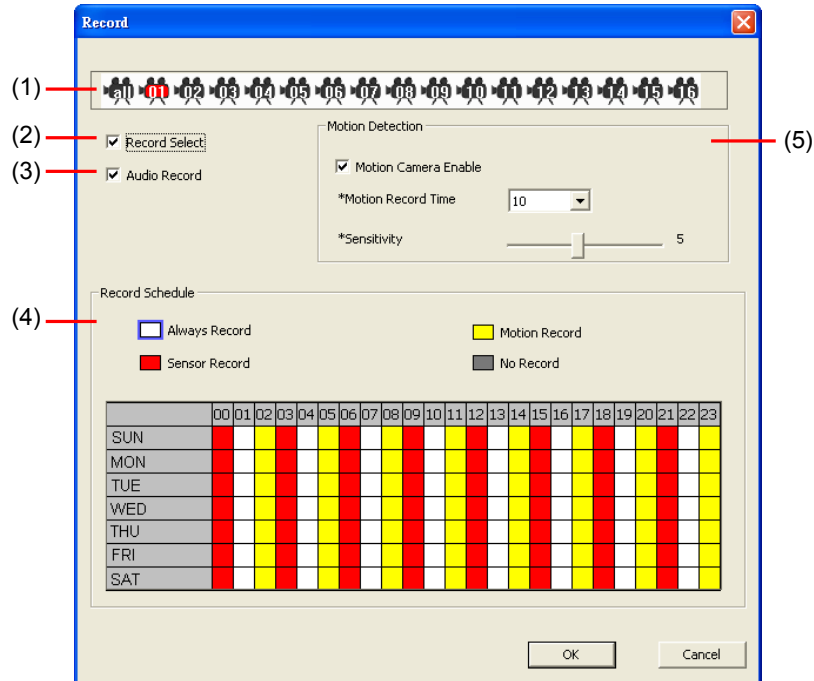

#### (1) Camera icon

Select the camera that user wants to set up.

#### (2) Record Select

Enable/disable the channel number to record video



The channels which could be recorded should be enabled in the **CAMERA SELECT** first.

#### (3) Audio Record

Enable/disable channel number audio recording. To record sound, make sure the microphone is connected to the unit

#### (4) Record Schedule

By default, in 24 hours, the recording schedule is set to always record every hour. Refer to the table below to customize the recording condition

Condition	Description
NO REC	Disable video recording
ALWAYS REC	Record non-stop
MOTION REC	Start recording when any movement is detected
SENSOR REC	Start recording when the sensor has triggered

#### (5) Motion Detection

- **Motion Camera Enable**  
Enable/disable the channel number to detect motion.
- **Motion Record Time**  
Set the amount of time (in second) to record when a motion has detected.
- **Sensitivity**  
Set the sensitivity level. The sensitivity is from high, 9~ 2 and low.

## 8.1.1.4 Alarm/Sensor Setup

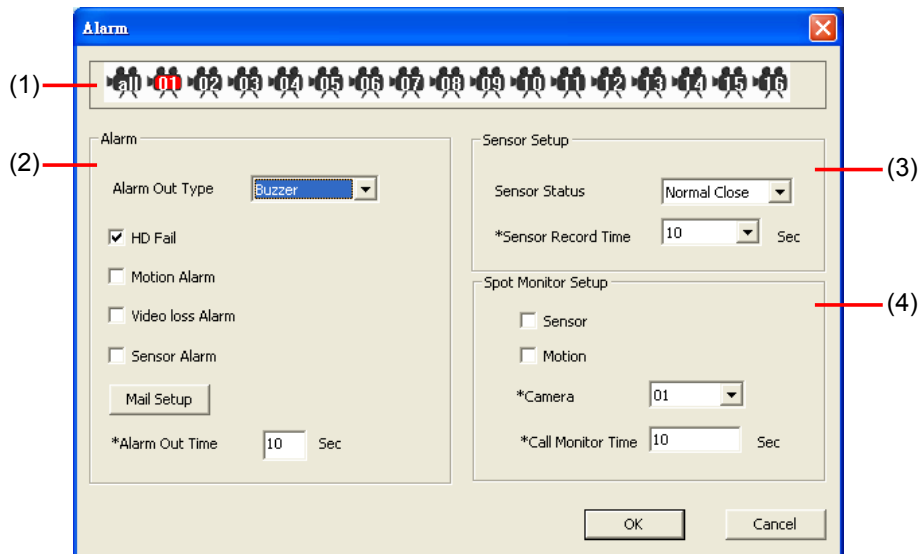

### (1) Alarm

- **ALARM OUT**  
Select the way of alarming – **BUZZER, RELAY-1, RELAY-2, RELAY-3, RELAY-4, or ALL.**
- **The Condition of Alarm**  
Select the condition that it will triggered the alarm
  - **HD Fail Alarm**  
Enable/disable send out alarm when hard disk is failed.
  - **Motion Alarm**  
Select the channel that will send out the alarm when motion has been detected
  - **Video Loss Alarm**  
Select the channel that will send out the alarm when video is lost.
  - **Sensor Alarm**  
Select the channel that will be send out the alarm when sensor has been triggered
- **E-Mail Setup**
  - **SMTP**  
Enter the SMTP server IP
  - **User ID & Password**  
Enter User ID and Password for e-mail server user identification
  - **From**  
Enter the sender e-mail address
  - **To**  
The recipient e-mail address and separate it with a semicolon
  - **Subject**  
Enter the message title
  - **Message**  
Type the message

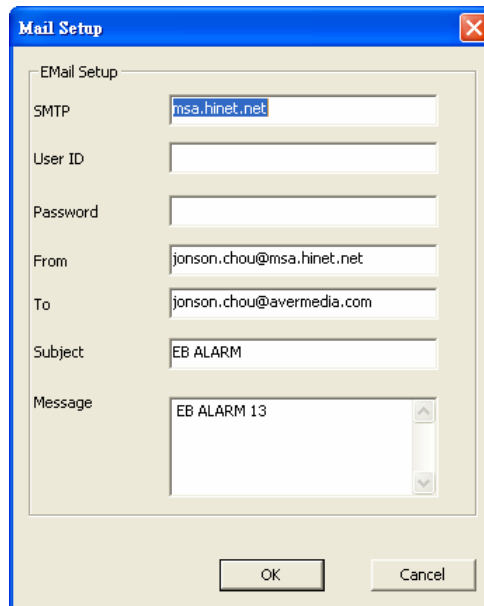

- **Alarm Out Time**  
Set the amount of time (in second) to continue sending the alarm once activated

### (3) Sensor Setup

- **Sensor Status**  
Customize the initial state of the attached sensor for every camera. Refer to the table below to customize the sensor state.
  - **Not installed:** Indicates that there is no sensor connected
  - **Normal open:** Indicates that the initial state of the sensor is normal open. Video recording initiate when there is a changes in the sensor state
  - **Normal close:** Indicates that the initial state of the sensor is normal close. Video recording initiate when there is a changes in the sensor state
- **Sensor Record Time**  
Set the amount of time (in second) to record after the sensor has been triggered

### (4) Spot Monitor

To display channel alarm event in full screen mode when the sensor is activated or motion is detected. When there are multiple alarm events, DVR system will display the last alarm event.

- **Sensor**  
Select the channel that will send out the alarm event for display when the sensor has been triggered.
- **Motion**  
Select the channel that will send out the alarm event for display when the motion has been detected.
- **Camera**  
Select the channel to display alarm event.
- **Call Monitor Time**  
Set a period time (0 ~ 255 sec) for alarm event to display on surveillance screen.

## 8.1.1.5 Network Setup

The screenshot shows the 'Network Setup' dialog box with the following fields and options:

- IP Mode:** Radio buttons for Static IP (selected), DHCP, and PPPOE.
- Option:** Checkboxes for Remote Audio Recording and UPNP Enable. Text boxes for Server Port (80) and UPNP Port (80).
- DDNS:** Text boxes for Domain Name and Auth Key.
- Static IP:** Text boxes for IP Mode (192 . 168 . 153 . 39), Mask (255 . 255 . 255 . 0), Gateway (192 . 168 . 153 . 254), and DNS (10 . 1 . 1 . 57).
- PPPOE:** Text boxes for User ID and Password.

### (1) IP Mode

Select the IP Mode – Static IP, DHCP, or PPPOE

#### - DHCP

Assign the IP address by local DHCP server to DVR system.



The Dynamic Host Configuration Protocol (DHCP) is a set of rules used by a communications device (such as a computer, router or networking adaptor) to allow the device to request and get an Internet address from a server which has a list of addresses available for assignment.

### (2) Option

#### - Remote Audio Recording

Enable/disable audio recording when recording at remote site.

#### - Server Port

A port is using for the remote connection. Any port can be assigned as a server port, except the ports already used by the network services.

#### - UPNP Enable

Enable/disable UPnP function that can automatically configure the port setting to the local router.

#### - UPNP Port

Assign a port for UPNP service using.

### (3) DDNS

DDNS (Dynamic Domain Name Service) is a data query service mainly used on the Internet for translating domain names into Internet addresses. Users can register their own domain name on <http://www.ddns.avers.com.tw>. (See [Appendix A](#))

#### - Domain Name

Enter the domain name that user wanted.

#### - Auth Key

A password use to access DDNS to register the domain name. MAC address of the DVR system is the key for user to register the domain name on AVerMedia DDNS web site. To find MAC address of your DVR system, follow the steps below:

1. In OSD menu, select **NETWORK SETUP**

2. Select any one of IP mode
3. A **NETWORK INFORMATION** windows will show up MAC address of DVR system is display as shown

IP MODE	
IP MODE	STATIC
IP ADDRESS	192 . 168 . 153 . 100
SUB NET	255 . 255 . 255 . 255
GATEWAY	192 . 168 . 153 . 254
DNS	000 . 000 . 000 . 000
MAC ADDRESS	00 . 18 . 1A . 02 . 00 . 0F
CHANGE	

#### (4) Static IP

Assign a fixed and global IP address for the DVR system

- **IP:** Assign a constant IP address which real IP addresses from ISP.
- **Mask:** Enter the subnet mask of the IP address which user has assigned to DVR system.  
 It is a bitmask used to tell how many bits in an octet(s) identify the subnetwork, and how many bits provide room for host addresses.
- **Gateway:** Enter the network gateway IP address
- **DNS:** Domain Name Server translates domain names (such as www.abb.com.tw) to IP addresses. It will translate the domain name into IP address when DVR system request.

#### (5) PPPOE

Point-to-Point Protocol over Ethernet is a network protocol for encapsulating PPP frames in Ethernet frames. It is used mainly with ADSL services.

**User ID & Password:** fill in the user account and password that user applied from your ISP for PPPOE connection.

## 8.1.1.6 User Setting

Click **Remote setup** button on Web Viewer main interface, and then, click **User** button to call out the **Password Change** interface.

The image shows a 'User' dialog box with three sections for password change. Each section has a label, a 'Password' field, and a 'Password Confirm' field. Red lines with numbers (1), (2), and (3) point to the labels 'SuperUser', 'Network User', and 'User' respectively. The dialog also has 'OK' and 'Cancel' buttons at the bottom.

### (1) Superuser

Change the remote accessing password of superuser. Superuser has the authority to remote setup the DVR system configuration on Web Viewer.

- **Password**  
Enter the new password
- **Password Confirm**  
Re-enter password to confirm

### (2) Network User

The login account for remote connection through the internet. User account only can view and playback recorded video by Web viewer (ex: Internet Explorer), but no authority to change the DVR system's setting. The factory default password is 111111.

- **Password**  
Enter the new password
- **Password Confirm**  
Re-enter password to confirm

### (3) User

Change the remote accessing password of user

- **Password**  
Enter the new password
- **Password Confirm**  
Re-enter password to confirm

## 8.2 Familiarizing the Remote Console Buttons



Name	Function
(1) Exit	Close the Remote Console.
(2) Audio button	Enable/disable the sound.
(3) Split Screen Mode	Select from six (6) different split screen type to playback the recorded video file of all the camera, or one camera over the other or alongside on a single screen.
<p><b>i</b> If there are only 4 cameras, you won't be able to switch to 9, 16, and 13 split screen mode.</p>	
(4) Record	Start/stop video recording.
(5) Network	Enable/disable remote system access. This feature allows you to access EB DVR server from a remote location via internet connection.
(6) Setup	Configure the Remote Console setting. (see also <a href="#">Chapter 8.2.1</a> )
(7) Preview	Switch to Preview/Playback mode. This allows you to view live camera display.
(8) Playback	Switch to Playback mode. This allows you to view the recorded video file. (see also <a href="#">Chapter 8.4</a> )
(9) Status Bar	Display the current date, time and hard disk free space.
(10) Camera ID	Show the number of cameras that are being viewed. When you are in single screen mode, click the camera ID number to switch and view other camera.
(11) Snapshot	Capture and save the screen shot either in *.jpg or *.bmp format.
(12) Full screen	Use the entire area of the screen to only display the video. To return, Right click the mouse or press ESC on the keyboard.
(13) DirectDraw	Enable/disable DirectDraw function

**i** Direct Draw function supports for certain VGA card. For more information, please contact your VGA card vendor.

## 8.2.1 To Setup Remote Console Setting

Click **Setup** button to call out the **System Setting** windows. Click **OK** to exit and save the setting and **Cancel** to exit without saving the setting.

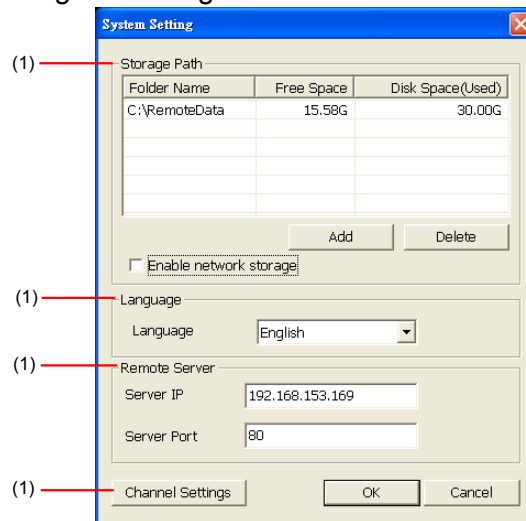

### (1) Storage Path

Set the directory on where to save the data. When there is not enough free space to record one hour data, the system automatically replaces the oldest data. In case you have more than one storage path, the system automatically saves the data to the next storage path. By default the data is stored in C:\RemoteData, to insert another storage path, click **Add**. To remove the selected path, click **Delete**.

- **Enable** network storage

Select the Enable network storage check box to send the recorded video in network-attached storage.



To add network storage, the Internet storage drive/folder must be mapped as Network Driver in DVR server. To know how to assign or connect to a network drive, please refer to your Windows help file and search "Map Network drive".

### (2) Language

Customize the system to display the tool tips and dialogs based on the selected language. By default the language is in English.

### (3) Remote Server

Enter the DVR Server IP and Server Port number.

### (4) Channel Settings

The numbers from 1 to 4 represent the camera ID. In Transmitting Channels section, enable the camera number to receive the camera signal from the server. In Visible Channels section, enable the camera number to view the camera signal on Remote Console screen. To select all the cameras, enable the **ALL** check box.

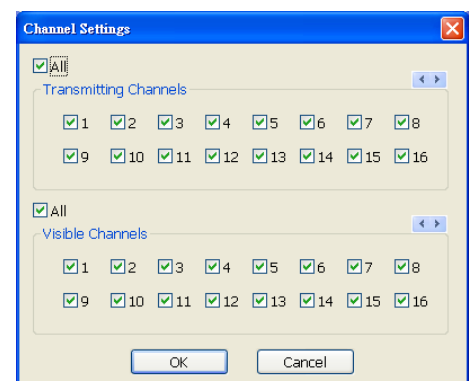

## 8.3 Familiarizing the WebViewer PTZ Buttons



Name	Function
(1) Direction buttons	Adjust and position the focal point of the PTZ camera. Click the center to pan automatically.
(2) Zoom +/-	Zoom in and out the image.
(3) Select PTZ	Choose to enable/disable the PTZ camera. In the Select PTZ dialog box, Select column, click to enable/disable viewing and controlling the PTZ camera. Click <b>OK</b> to exit and save the setting and <b>Cancel</b> to exit without saving the setting.
(4) Focus +/-	Adjust the focus manually to produce clear image.
(5) Camera preset position number	Move the PTZ camera to the preset point. The reset point (1~9) is based on the user has setup by remote control at local site.

## 8.4 Using the Remote Playback

To use this feature, first you need to select the source of the file. Click the **Playback** button. And then, in the Select Playback Mode dialog box, choose **Local Playback** to open the file that is recorded in the Remote Console, and **Remote Playback** to open the file that is recorded in the DVR server. When you choose Remote Playback, select **Download and Playback**.



Click **OK** to proceed and **Cancel** to void this operation.

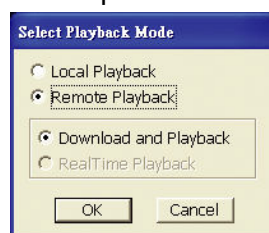

In the Video Playback Date/Time Selection, the number from 00 to 23 represent the time in 24-hour

clock. The numbers from 01 to 16 represent the camera number.

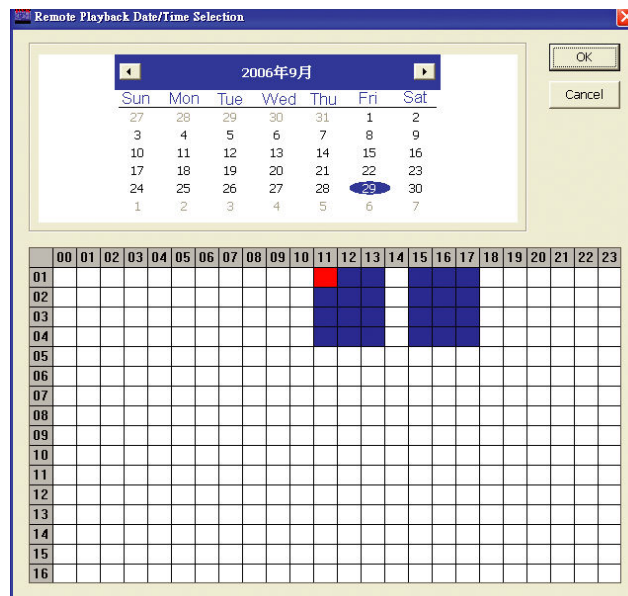

### To Make a Selection:

1. Select the date in the calendar. Use ◀ and ▶ buttons to shift the calendar to the left or right.
2. In the table below, click on the blue block to select and open the recorded file. The blue block turns red when it is selected. The block that appears in white doesn't have data. You can only select one block when you choose Download and Playback.
3. Click **OK** to proceed and **Cancel** to void this operation.
4. If you select Download Playback and after making the selection, the system divides the selected hour into 16 video thumbnails. In the Time Selection screen, click on the video thumbnail you want to download (see also [Chapter 8.3.2](#)).

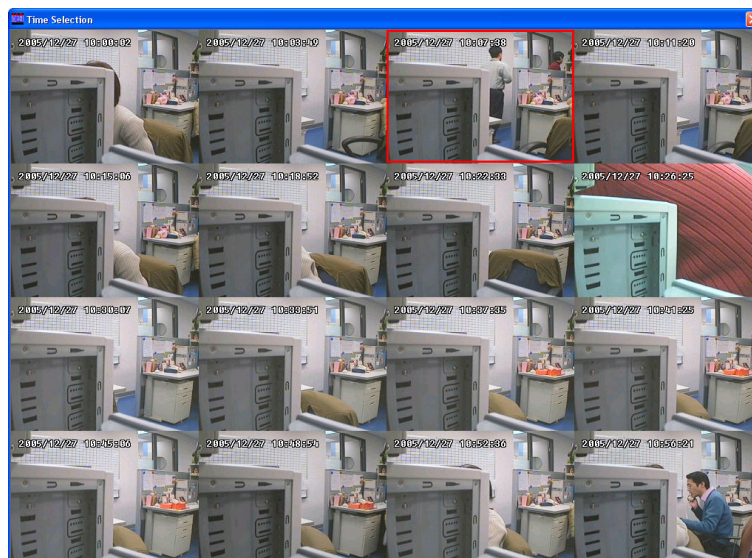

## 8.4.1 Familiarizing the Local Playback Buttons

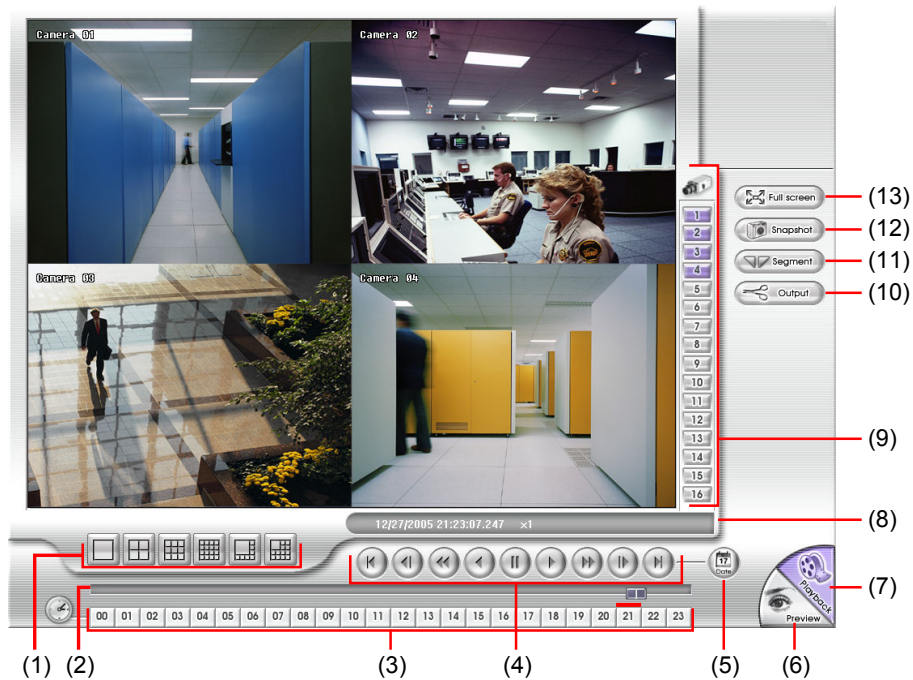

Name	Function
(1) Split Screen Mode	Select from six (6) different split screen type to playback the recorded video file of all the camera, or one camera over the other or alongside on a single screen.
<b>i</b>	<ul style="list-style-type: none"> <li>- If there are only 4 cameras, you won't be able to switch to 9, 16, and 13 split screen mode.</li> <li>- To zoom in an area on the screen, Right click and Drag a square on the area you want to enlarge. To back to normal view, right click the channel screen again.</li> </ul>
(2) Progress bar	Show the progress of the file being played. You may move the bar to seek at any location of the track.
(3) Hour Buttons	Select and click to playback the recorded video file on the specific time frame.
<b>i</b>	The Hour buttons represent the time in 24-hour clock. The blue bar on top of the hour button indicates that there is a recorded video file on that period of time. If there is no recorded data within the hour, there will be no color bar on top of the hour button. While the red bar indicates that you are currently viewing the recorded video file.
(4) Playback Control Buttons	<p><b>Begin:</b> Move at the beginning of the recorded video file.</p> <p><b>Previous:</b> Go back to the previous frame.</p> <p><b>Slower:</b> Play the recorded video file at the speed of ½x, ¼x, or ⅓x.</p> <p><b>Rewind:</b> Wind back the video file.</p> <p><b>Pause:</b> Briefly stop playing the recorded video file.</p> <p><b>Play:</b> Play the recorded video file.</p> <p><b>Faster:</b> Play the recorded video file at the speed of 2x, 4x, or 8x.</p> <p><b>Next:</b> Go to the next frame.</p> <p><b>End:</b> Go to the end of the video file.</p>
(5) Date	Select the date on the calendar and the time from 00 to 23 to where to start playing the recorded video file.
<b>i</b>	The numbers from 00 to 23 represent the time in 24-hour clock. The numbers from 01 to 16 represent the camera ID. While the red colored column indicates on where to start playing the recorded video file. If there is no any video data, it will be no color bar on top of the date button.
(6) Preview	Switch to Preview/Playback mode.
(7) Playback	Switch to Playback mode. This allows you to view the recorded video file.
(8) Status bar	Display the record date, time, HDD capacity in preview mode and play speed

Name	Function
	in playback mode.
(9) Camera ID	Show the number of cameras that are being viewed. When you are in single screen mode, click the camera ID number to switch and view other camera.
(10) Output	Save the segmented file in *.mpg, *.avi, or *.dvr format (see also <a href="#">Chapter 8.3.1.1</a> ).
(11) Segment	Keep a portion of the recorded video you want (see also <a href="#">Chapter 8.3.1.1</a> ).
(12) Snapshot	Capture and save the screen shot either in *.jpg or *.bmp format.
(13) Full screen	View in Playback-compact mode. To return, press the right button of the mouse or ESC on the keyboard.

### 8.4.1.1 To Cut and Save the Wanted Portion of the Recorded Video

1. Use the Playback Control buttons or drag the bar on the playback progress bar and pause on where you want to start the cut. Then, click Segment to set the begin mark.



2. Use the Playback Control buttons or drag the bar on the playback progress bar and pause on where you want to end the cut. Then, click Segment to set the end mark. To cancel segmentation or set the segment marks from the start, click Segment button again.



3. Click Output button to save the wanted clip.
4. In the Save As dialog box, locate on where you want to save the file, type the filename, and select the video format.

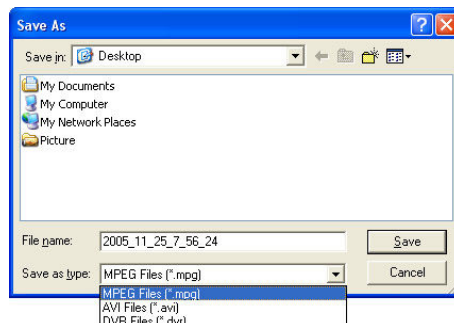

## 8.4.2 Familiarizing the Download and Playback Buttons

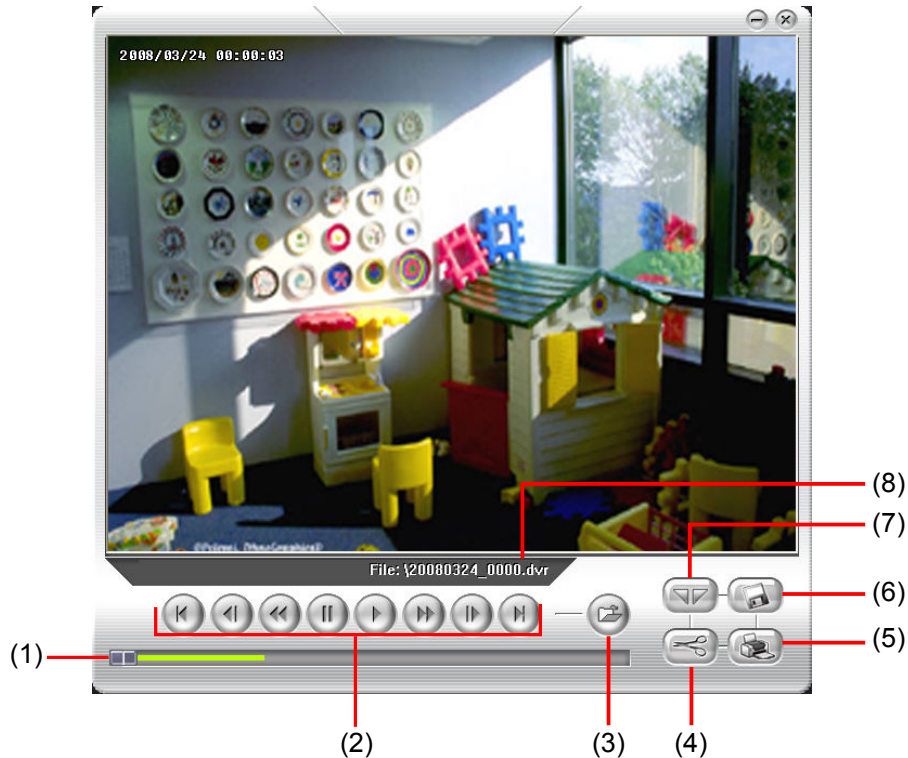

Name	Function
(1) Progress bar	Show the progress of the file being played. You may move the bar to seek at any location of the track.
(2) Playback Control Buttons	<p><b>Begin:</b> Move at the beginning of the video file.</p> <p><b>Previous:</b> Go back to the previous frame.</p> <p><b>Slower:</b> Play the recorded video file at the speed of 1/2x, 1/4x, or 1/8x.</p> <p><b>Rewind:</b> Wind back the video file.</p> <p><b>Pause:</b> Briefly stop playing the recorded video file.</p> <p><b>Play:</b> Play the recorded video file.</p> <p><b>Faster:</b> Play the recorded video file at the speed of 2x, 4x, 8x, or 16x.</p> <p><b>Next:</b> Go to the next frame.</p> <p><b>End:</b> Go to the end of the video file.</p>
(3) Date	Open other file.
(4) Output	Save the segmented file in *.mpg or *.avi format.
(5) Print	Print the screen shot.
(6) Save	Save the screen shot either in *.jpg or *.bmp format and video in *.dvr format.
(7) Segment	Keep a portion of the recorded video you want. You may follow the instruction in <a href="#">Chapter 8.3.1.1</a> .

## Warranty Notice

### LIMITED WARRANTY

AVerMedia INFORMATION, Inc. warrants this product to be free of defects resulting from faulty manufacture or components under the following terms:

### WARRANTY LENGTH

Labor is warranted for (1) one year from the date of purchase

Parts are warranted for (1) one year from the date of purchase

Replacement products will be warranted for the remainder of the one year warranty period or (30) thirty days, whichever is longer

### WHO IS PROTECTED

This warranty is enforceable only by the first consumer purchaser

### WHAT IS AND IS NOT COVERED

Except as specified below, this warranty covers all defects resulting from faulty manufacturing of this product. The following are not covered by the warranty.

1. Any product on which the serial number has been defaced, modified, or removed
2. Damage, deterioration, or malfunction resulting from:
  - Accident, abuse, misuse, neglect, fire, water, lightning, or other acts of nature, commercial or industrial use, unauthorized product modification, or failure to follow instructions included with the product.
  - Misapplication of service by someone other than the manufacturer's representative
  - Any shipment damages (Claims must be made with carrier)
  - Any other cause which does not relate to a product defect
3. Cartons, cases, batteries, cabinets, tapes, or accessories used with product
4. AVerMedia does not warrant that this product will meet your requirements; it is your responsibility to determine the suitability of this product for your purpose

### WHAT WE WILL AND WILL NOT PAY FOR

We will pay labor and material expenses for covered items. However, we will not pay for the following:

1. Removal or installation charges
2. Shipping charges
3. Any incidental charges

### EXCLUSION OF DAMAGES

THE MANUFACTURER'S SOLE OBLIGATION AND LIABILITY UNDER THIS WARRANTY IS LIMITED TO THE REPAIR OR REPLACEMENT OF A DEFECTIVE PRODUCT AT OUR OPTION. THE MANUFACTURER SHALL NOT, IN ANY EVENT, BE LIABLE TO THE PURCHASER OR ANY THIRD PARTY FOR ANY INCIDENTAL OR CONSEQUENTIAL DAMAGE (INCLUDING, BUT NOT LIMITED TO, DAMAGES RESULTING FROM INTERRUPTION OF SERVICE AND LOSS OF BUSINESS) OR LIABILITY IN TORT RELATING TO THIS PRODUCT OR RESULTING FROM ITS USE OR POSSESSION.

### LIMITATIONS OF IMPLIED WARRANTIES

There are no other oral or written warranties, expressed or implied, including but not limited to those of merchantability or fitness for a particular purpose. Any implied warranties are limited in duration to one year from the date of purchase

### STATE LAW AND YOUR WARRANTY

This warranty gives you specific legal rights, and you may also have other rights granted under state law. These rights vary from state to state

### CONTACT INFORMATION

Taiwan & International  
No. 135, Jian Yi Rd., Chung Ho City, Taipei, Taiwan  
TEL: 886-2-2226-3630  
FAX: 886-2-2226-7241  
Web Site: <http://www.avermedia.com> / <http://www.averdigi.com>